

TOTO

TOTO U.S.A., Inc. 1155 Southern Road Morrow, GA 30260
Phone : (770) 282 8686

Warranty Registration and Inquiry

For product warranty registration, TOTO U.S.A. Inc. recommends On-Line Warranty Registration. Please visit our web site <http://www.totousa.com>. If you have questions regarding warranty policy or coverage, please contact TOTO U.S.A. Inc., Customer Service Department, 1155 Southern Road, Morrow, GA 30260 (888) 295 - 8134 or (678) 466 - 1300 when calling from outside of U.S.A.

- TOTO ASIA OCEANIA PTE. LTD.** 10, Eunos Road 8, #12-07, Singapore Post Centre. Singapore 408600.
Phone : +65-6744-6955 Fax : +65-6841-0819 <http://asia.toto.com/>
- TOTO ASIA OCEANIA PTE. LTD.** Middle East Branch LOB19-1701-1702, Jebel Ali Free Zone, P.O. box 261804, Dubai U.A.E.
Phone : +971-4-886-5983 Fax : +971-4-886-5986 <http://asia.toto.com/>
- TOTO ASIA OCEANIA PTE. LTD.** Manila Representative Office. Unit 1010, 10th Floor Rufino Building, Ayala Avenue cor.V.A. Rufina Street, Makati City, 1226 Philippines.
Phone : +63-2-887-6643 Fax : +63-2-887-4084 <http://asia.toto.com/>
- TOTO LTD.** Bangkok Representative Office G Floor, Q.House Ploenjit Building, 598 Ploenchit Road, Lumpini, Pathumwan, Bangkok 10330 Thailand
<http://www.totobkk.com/>
- TOTO INDIA INDUSTRIES PVT. LTD** Head office 506, 5th Floor, ASCOT Center, Sahar Airport Road, Andheri (East) Mumbai 400099, Maharashtra, India.
Phone : +91-22-2832-5741/5742 Fax : +91-22-6725-8780 <http://asia.toto.com/>
- TOTO INDIA INDUSTRIES PVT. LTD** Delhi Branch 909-909A, 9th Floor, Block-E, International Trade Tower, Nehru Place, New Delhi 110019, India.
Phone : +91-11-4654-2421 to 26 Fax : +91-11-4654-2430 <http://asia.toto.com/>
- TOTO VIETNAM Co., Ltd.** Ha Noi Branch R. 810, Daeha Business Centre, 360 Kim Ma St., Ba Dinh Dist., Ha Noi City
Phone : +84-4-37714354 Fax : +84-4-37714355 <http://toto.com.vn/>
Da Nang Branch 10th Floor, ACB Building, 218 Bach Dang Str., Hai Chau Dist., Da Nang City
Phone : +84-511-3565261 Fax : +84-511-3565262 <http://toto.com.vn/>
Ho Chi Minh Branch R. 1301, Centec Tower, 72-74 Nguyen Thi Minh Khai Str., Dist. 3, Ho Chi Minh City
Phone : +84-8-38229520 Fax : +84-8-38229522 <http://toto.com.vn/>

- You are advised to record the following information to allow quick service.

Date of purchase :	Name of shop :
Date : year month day	Tel : ()

2012.7.30
D08692R

TOTO

WASHLET NEOREST

Instruction Manual with Warranty

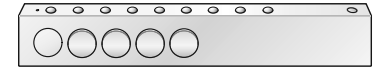

NEOREST

550H SN982M (MS982CUMG)
TCF9786JA

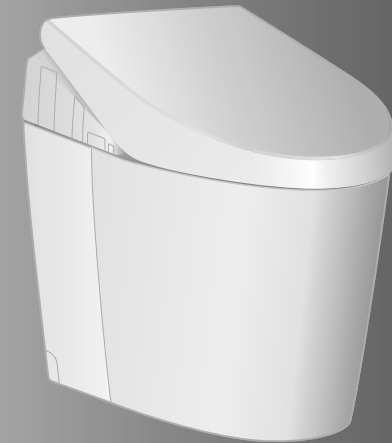

- Thank you for your recent purchase of the TOTO Washlet. Please read the enclosed information to ensure the safe use of your product.
- Be sure to read this Instruction Manual before using your product and keep it in a safe place for future reference.

What functions are available on your product?

The model name and part number are indicated on the bottom side of the toilet lid.

<Product model number>
Top unit + Bowl unit = Combination model number *
SN** CT**** MS******
TCF** CS******

* The combination model number indicated is for the U.S. model only.

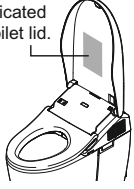

Functions		Model	NEOREST	Ref. Page
		Part No.	SN982M TCF9786JA	
Basic Functions	Cleansing	Rear cleansing	●	16, 17
		Soft rear cleansing	●	
		Front cleansing	●	
		Wide front cleansing	●	
	Changing the washing method	Wand position adjustment	●	
		Water pressure adjustment	●	
		Oscillating cleansing	●	
		Pulsating cleansing	●	
		Personal setting lock	●	
	Drying	Warm Air Drying	●	
Changing the temperature	Temperature Adjustment	●	22, 23	
Convenient Functions	Flushing	Remote control bowl unit cleaning	●	17, 18, 19
		Auto bowl unit cleaning	●	
	Opening and closing	Opening and closing the toilet seat with remote control	●	18, 19
		Auto lid opening and closing	●	
	Lighting up	Soft light	●	—
	Heating the toilet seat	Heated seat	●	—
		Saving energy	Timer energy-saver	●
Auto energy-saver	●			
Sanitary Functions	"ewater+" sanitizing	Auto wand cleaning	●	20, 21
		Auto bowl cleaning	●	
	Removing odors	Deodorizer	●	
Maintenance		Bowl unit cleaning	●	29
		Cleaning lift lever	●	30
		Removable toilet lid	●	31
		Wand cleaning	●	35

Cleaning Support Sanitary Toilet



- | As you Approach | As you stand up | As you move away |
|---|---|--|
| <ul style="list-style-type: none"> A mist is sprayed in the bowl unit to make it more difficult for dirt to adhere. When you sit on the toilet seat, the deodorizer operates. | <ul style="list-style-type: none"> The wand is cleaned with "ewater+". (The wand extends and then retracts.) | <ul style="list-style-type: none"> "ewater+" is sprayed in the bowl unit to maintain cleanliness. |



Table of Contents

	Introduction	Operation	Maintenance	Reference
Safety Precautions.....	4			
Operational Precautions.....	11			
Parts names.....	12			
Preparation	14			
Basic Operations.....	16			
Automatic Functions (Convenience Features)	18			
Automatic Functions (Cleaning Features)	20			
Temperature Adjustment	22			
Energy-saver Features.....	24			
Power plug	28			
Top unit/Bowl Unit	29			
Gap between the Top Unit and the Bowl Unit	30			
Gap between the Top Unit and the Toilet Lid.....	31			
Water Filter Drain Valve	32			
Deodorizing Filter	34			
Wand.....	35			
Water filter (Bowl unit)	36			
Changing Settings.....	38			
What to Do?	52			
● If there is no water due to a power outage or water failure.....	52			
● If you cannot operate with the remote control.....	52			
● Long Periods of Disuse	53			
● Freeze Damage Prevention	54			
Troubleshooting	55			
Specifications	62			
Warranty	63			



Safety Precautions

These precautions are important for safe usage. Be sure to follow them and use the product correctly.

Symbols and meanings

	WARNING	May result in death or serious injury.
	CAUTION	May result in injury or property damage.



The following symbols are used to indicate important safety instructions for the use of the product.

Symbol	Definition
	The symbol indicates a prohibited use of the product.
	The symbol is used to indicate a required step in the use of this product.

WARNING

	<p>Do not plug or unplug the power plug with wet hands.</p> <ul style="list-style-type: none"> • Doing so may cause electrical shock. <p>Do not get any water or cleaning solution on the top unit or power plug.</p> <ul style="list-style-type: none"> • Doing so may cause a fire, electrical shock, heat or a short. • Doing so can cause the product to crack resulting in injury or water damage. <p>Never disassemble, repair or alter.</p> <ul style="list-style-type: none"> • Doing so may cause a fire, electrical shock, heat or a short. <p>Do not install the Washlet on moving vehicles such as RV's or boats.</p> <ul style="list-style-type: none"> • Doing so could cause fire, electric shock, short or malfunction. • The toilet seat, lid, top unit or other part might come loose and fall, resulting in injuries. <p>Do not use the Washlet if a malfunction occurs.</p> <p>[North, Central, South America]</p> <p>In the following cases, unplug the plug out from the outlet and close the water supply valve.</p> <p>[Asia, Oceania, Middle East]</p> <p>In the following cases, switch the breaker on the distribution board to OFF and close the water supply valve.</p> <p>Possible malfunctions:</p> <ul style="list-style-type: none"> -Water is leaking from a pipe or the top unit -The product is cracked or broken. -The product makes a strange noise or emits a strange odor. -The product emits smoke. -The product is abnormally hot. -The bowl unit is clogged. -The toilet seat cushion is out of place. <ul style="list-style-type: none"> • Continued use after malfunction could cause a fire, electrical shock, heat, short, injury or water damage.
---	--

WARNING

	<p>Only use tap water or potable well water (underground water). Do not use seawater.</p> <ul style="list-style-type: none"> • Doing so may cause irritation to the skin and malfunction. <p>Do not touch the power plug during thunderstorms.</p> <ul style="list-style-type: none"> • Doing so may cause electrical shock. <p>Do not allow the water supply hose to touch the power plug or outlet.</p> <ul style="list-style-type: none"> • Doing so may cause condensation resulting in a fire, electrical shock, heat or a short. <p>Do not do anything that could damage the power cord, power plug or toilet seat cord.</p> <p>Do not strike, yank, twist, excessively bend, damage, alter, or heat the electrical cords. Also, do not place anything heavy on, bind or pinch the electrical cords.</p> <ul style="list-style-type: none"> • Using a damaged electrical cord may result in a fire, electrical shock, heat or short. <p>Do not use a loose or faulty electrical outlet.</p> <ul style="list-style-type: none"> • Doing so could cause a fire or a short. <p>Do no use any outlet or wiring equipment beyond its specified rating.</p> <ul style="list-style-type: none"> • Plugging too many plugs into the same outlet, for example using outlet splitters, can cause fire due to heat. <p>Do not use any power supply other than the one specified.</p> <p>[North, Central, South America]</p> <p>AC120 V, 60Hz</p> <p>[Asia, Oceania, Middle East]</p> <p>AC220 V, 50/60Hz</p> <ul style="list-style-type: none"> • Doing so could cause a fire or excessive heat. <p>Do not stick a finger or anything else into the warm air outlet.</p> <p>Do not place anything on the warm air outlet or drape clothes over it.</p> <ul style="list-style-type: none"> • Doing so could cause burns, electrical shock or malfunction.
	<p>Beware of irritation or burn</p> <ul style="list-style-type: none"> • Improper use of heated toilet seats could cause irritation or burn. <p>When sitting for a long time on the toilet seat, switch the toilet seat temperature adjustment to "OFF".</p> <p>When any of the following persons use a heated seat or warm air drying, someone should switch the toilet seat temperature adjustment to "OFF" and switch the drying air temperature to "Low".</p> <ul style="list-style-type: none"> - Young children, the aged and other users unable to set the temperature appropriately themselves - The ill, physically disabled and others who do not have freedom of movement - Those using any medicines that cause drowsiness (sleeping or cold medicine), those who have been drinking heavily, anyone severely fatigued and anyone else liable to fall asleep <p>Always connect the Washlet to the cold water supply</p> <ul style="list-style-type: none"> • Connecting to hot water supply may result in burns and equipment damage. <p>Make sure that a properly grounded (3 prong) outlet has been installed.</p> <ul style="list-style-type: none"> • Failure to install a grounded outlet could cause electrical shock in the event of a malfunction or short circuit. <p>Do not unplug by pulling the cord.</p> <p>To unplug, hold the plug, not the cord.</p> <ul style="list-style-type: none"> • Pulling on the cord may cause damage and result in fire or heat.

Safety Precautions (Continued)

WARNING

This is an electrical product. Do not install it anywhere water is likely to get on the product or anywhere with humidity high enough that water is likely to form on the surface of this product. When using the product in a bathroom, install a fan or ventilation port and ensure good air flow through the bathroom.

- Failure to do so could cause a fire or electrical shock.

If the electric cord is damaged, avoid danger by having the manufacturer's repair department or equivalent specialist replace it.

[North, Central, South America]

Insert the power plug securely into the outlet.

- Failure to do so could cause a fire, heat or a short.

Periodically remove dust and dirt from the electrical plug and make sure it is securely plugged into the wall outlet.

- Failure to do so could cause a fire, heat or a short.
- Pull the plug out from the outlet and wipe clean with a dry cloth.

Always unplug the plug from the outlet before cleaning or maintenance.

- Failure to do so may cause electrical shock.
- Except when using "Wand cleaning" or "Bowl unit cleaning".

Always unplug the plug from the outlet before removing the top unit.

- Failure to do so could cause a fire or electrical shock.

[Asia, Oceania, Middle East]

Check that the power plug is waterproofed with silicone rubber.

- A power plug that is not water-proofed could cause a fire and electrical shock.
- * If the power plug is not water-proofed, ask the contractor who did the installation to water-proof it.

Check that an appropriate ground is installed.

- If the ground is not installed, if there is a breakdown or electrical current leak, the lack of a ground could cause electrical shock.
- For the ground, use copper wire with a ground resistance of 100 Ω max. and a diameter of 0.005 ft (1.6 mm) min.
- * If there is no ground installed, ask the contractor who did the installation to install the ground.

Check that the outlet for electrical power is as follows.

- Failure to do so could cause a fire or electrical shock.
- a. Protect the outlet circuits with a high-sensitivity quick leakage switch (with a rated current sensitivity of 15mA or less) or an insulating transformer (1.5kVA min., 3kVA max.).
- b. Install the outlet and plug positioned at least 2.62 ft (0.8 m) above the floor and as far as possible from the bathtub.
- * Check that the wiring in a. and b. above is complete. If the wiring has not been completed, ask the contractor who did the installation to do it.

Always switch the breaker on the distribution board to OFF before cleaning or maintenance.

- Doing so may cause electrical shock.
- Except when using "Wand cleaning" or "Bowl unit cleaning".

Always switch the breaker on the distribution board to OFF before removing the top unit.

- Failure to do so could cause a fire or electrical shock.



CAUTION

Keep cigarettes and other open flames away from this product.

- Failure to do so could cause a fire.

When cleaning or maintaining the plastic parts (top unit etc.) or the water supply hose, use a kitchen cleaner diluted with water. Do not use any of the following.

Toilet cleaner, household cleaner, benzene, paint thinner, powdered cleanser or nylon scrubbing pads.

- These items could damage or crack the plastic and cause injury or malfunction.
- These items could damage the water supply hose and cause a water leak.

Do not apply strong force, mechanical shock, step on or stand on the toilet seat, toilet lid or top unit. Also do not place any heavy object on the toilet seat, toilet lid or top unit.

- Doing so could cause cracking or cause the top unit to come loose and fall resulting in injury.
- Doing so could damage the product and cause injury or water damage.

Do not lift up this product by the toilet seat or lid.

Do not raise the toilet seat or lid while objects are resting on top of the toilet.

- Doing so could cause the top unit to come loose and fall resulting in injury.

Do not fold or crush the water supply hose.

- Doing so could cause water leaks.

To prevent a sudden water leak, do not remove the water filter drain valve when the water supply valve is open.

- Doing so will cause water to spurt out.
- Refer to Page 32 for instructions on cleaning the water filter drain valve.

Do not flush anything other than bodily waste and toilet paper. Also, do not flush too much toilet paper.

- Doing so could clog the toilet, causing waste water overflow and water damage.

Do not pour hot water into the toilet.

- Doing so may result in damage to the toilet, injury or water damage.

If the product is damaged, do not touch the damaged section.

- Doing so could cause injury.

When operating the lift lever for cleaning, do not insert your fingers into the gap between the top unit and the bowl unit.

Do not use the product while the top unit is lifted up.

Do not use the product if the top unit is unstable.

- Doing so could cause the top unit to come loose and fall, resulting in injury.



Safety Precautions (Continued)

CAUTION

If a water leak should occur, always close the water supply valve.

Preventing damage to pipes and hoses due to freezing

- Frozen water pipes could cause the top unit and the pipes to break, resulting in a water leak. Regulate the room temperature to prevent the pipes and hoses from freezing during cold months.

When installing the water filter drain valve, make sure that it is securely tightened in its proper position.

- Failure to securely tighten it might cause water leaks.

Always flush, even after just urinating.

- Failure to do so could result in inadequate flushing and clog the bowl unit, causing waste water overflow and water damage.

Wipe any urine, condensation, cleaner, water, etc. that has gotten on the floor with a well-wrung mop or cloth.

- Failure to do so could cause staining of the floor and corrosion.

[North, Central, South America]

When not using the Washlet over an extended period of time, drain the water out of the top unit and the water supply hose, and pull the electrical plug from the outlet.

When using the product again, allow the product to refill with water first.

- Otherwise, the water in the tank might become contaminated and cause skin inflammation or other problems.
- Leaving the power ON might cause a fire or heat.

If the bowl unit is clogged, disconnect the power plug and remove the clog.

- If the auto bowl unit flush were allowed to function, it would make the wastewater in the bowl unit overflow resulting in water damage. Use any commonly available toilet plunger to remove the clogging.

[Asia, Oceania, Middle East]

When not using the Washlet over an extended period of time, drain the water out of the top unit and the water supply hose, and switch the breaker on the distribution board to OFF.

When using the product again, allow the product to refill with water first.

- Otherwise, the water in the tank might become contaminated and cause skin inflammation or other problems.
- Leaving the power ON might cause a fire or heat.

If the bowl unit is clogged, switch the breaker on the distribution board to OFF and remove the clog.

- If the auto flush were allowed to function, it would make the wastewater in the bowl unit overflow and may result in water damage. Use any commonly available toilet plunger to remove the clogging.

DANGER To reduce the risk of electrocution:

1. Do not use while bathing.
2. Do not place or store the product where it can fall or be pulled into a tub or sink.
3. Do not place in or drop into water or other liquid.
4. Do not reach for the product when it has fallen into water. Unplug it immediately.

DANGER To reduce the risk of burns, electrocution, fire or injury to persons:

1. Close supervision is necessary when this product is used by, on, or near children or invalids.
2. Use this product only for its intended use as described in this manual. Do not use attachments not recommended by the manufacturer.
3. Never operate this product if it has a damaged cord or plug, is not working properly, has been dropped or damaged, or has been dropped in water. Return the product to a service center for examination and repair.
4. Keep the cord away from heated surfaces.
5. Never block the air openings on the product or place it on a soft surface, such as a bed or couch, where the air openings may be blocked. Keep the air openings free of lint, hair, and other similar items.
6. Never use while sleepy or drowsy.
7. Never drop or insert any object into any opening or hose.
8. Do not use outdoors. Do not operate where aerosol (spray) products are being used or where oxygen is being administered.
9. Connect this product to a properly grounded outlet only.
See "Grounding Instructions" in Page 10.
10. The tank should be filled with water only.

Safety Precautions (Continued)

Grounding Instructions

This product should be grounded. In the event of an electrical short circuit, grounding reduces the risk of electric shock by providing an escape wire for the electrical current.

The plug must be plugged into an outlet that is properly installed and grounded.

⚠ DANGER - Improper use of the grounding plug can result in a risk of electric shock. If repair or replacement of the cord or plug is necessary, do not connect the grounding wire to either flat-head terminal.

Check with a qualified electrician or serviceman if the grounding wire instructions are not completely understood, or if in doubt as to whether the product is properly grounded.

This product is factory equipped with a specific electric cord and plug to permit connection to a proper electric circuit. Make sure that the product is connected to an outlet having the same configuration as the plug.

No adapter should be used with this product. Do not modify the plug provided - if it will not fit in the outlet, have the proper outlet installed by a qualified electrician.

If the product must be reconnected for use on a different type of electric circuit, the reconnection should be made by qualified service personnel.

If it is necessary to use an extension cord, use only a three wire extension cord that has a three blade grounding plug, and a three-slot receptacle outlet that will accept the plug on the product.

Replace or repair a damaged cord.

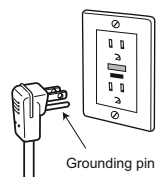

Save these instructions.

Operational Precautions

■ For prevention of malfunctions

- Do not block the body sensor or the remote control transmitter or receiver.

<About the Body Sensors>

Two types of body sensor are used.

- **Body sensor A detects changes in heat.**
 - Detection may be difficult when the room temperature exceeds 86°F (30°C), such as in the summertime.
 - When sunlight is directly on the sensor area or a heater is used in the bathroom, the sensor may detect incorrectly due to the heat, resulting in the automatic operation of functions such as auto lid opening and closing.
 - When the bathroom door is open, the sensor may detect people who pass to the front or side of the toilet.
 - **Body sensor B detects when someone stands in front of the bowl unit.**
 - Body sensor B emits an infrared beam as shown in the figure. When someone moves into the line of this infrared beam, the sensor detects the person.
- * Detection by the sensor may be difficult when the toilet is used by someone small, such as a child.

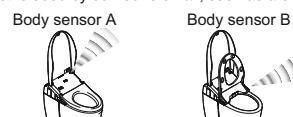

<About the seat switch>

- **When you sit on the toilet seat, the seat switch turns ON, enabling you to use various features.** (A click sound is heard when the seat switch is ACTIVATED.)
-
- **The seat switch will not turn on unless you sit on the seat properly.**



Note

- When a child uses the Washlet, the seat switch may not be ACTIVATED their light body weight.
- Since the toilet seat is designed to move up and down, a clearance is provided between the toilet seat cushion and the bowl unit.

■ For prevention of damage

- Wipe plastic areas such as the top unit and remote control with a soft, wet cloth.



- Do not lean against the toilet lid.

■ Problem Prevention

[North, Central, South America]

- Disconnect the power plug if there is a risk of lightning.

[Asia, Oceania, Middle East]

- Switch the breaker on the distribution board to OFF if there is a risk of lightning.
- A toilet seat cover or a toilet lid cover cannot be used. (The body sensor or seat switch may not function properly.)



- Do not urinate on the top unit, toilet seat or wand. (Doing so may cause pink or brown stains or a malfunction.)
- Do not apply strong forces to the control panel of the remote control.
- When using a toilet cleaner to clean the toilet, wash it off within 3 minutes and leave the toilet seat and toilet lid open.
 - Wipe off any cleaner that remains on the bowl unit. (If vapor from a toilet bowl cleaner enters the top unit, it may cause a malfunction.)
- Do not expose to direct sunlight. (Doing so may cause temperature changes resulting in changes in color, irregular heated seat temperature, a remote control malfunction or a Washlet malfunction.)
- Use radios, etc. away from the Washlet. (The Washlet could cause interference with the radio signal.)
- If you use a booster seat for infants or a soft highchair, remove it after use. (Keeping it installed may prevent some of the functions from being used.)
- Do not apply force to the remote control. (May cause malfunctions.) To prevent the hangar from being dropped, set it in the remote control hanger when you are not using it. Be careful not to expose it to water.

About rear cleansing, soft rear cleansing, front cleansing and wide front cleansing

- These functions wash away waste and dirt from a localized area of your body.
- Do not cleanse too much or for too long. Doing so may wash away normal bacteria, upsetting the balance of bacteria inside your body.
- People who are receiving medical treatment or therapy in this localized area should consult their doctor before use.

Parts Names

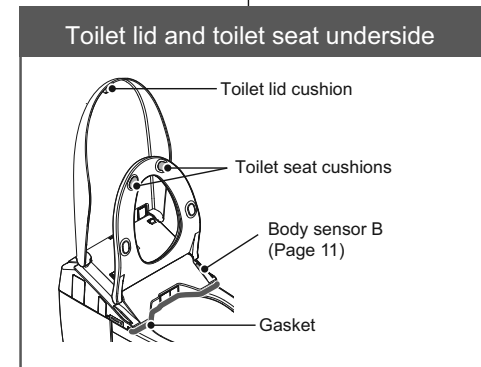
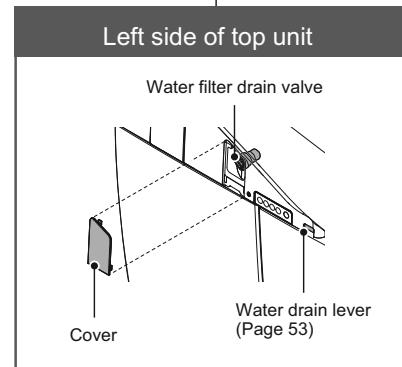
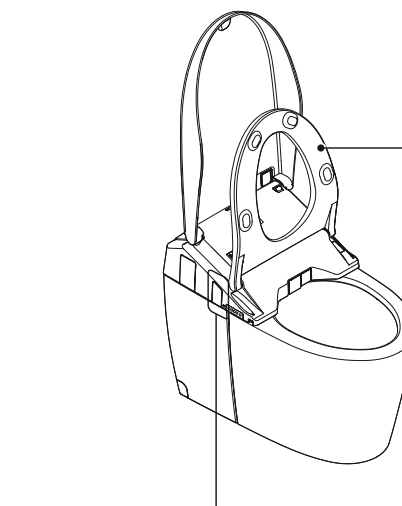
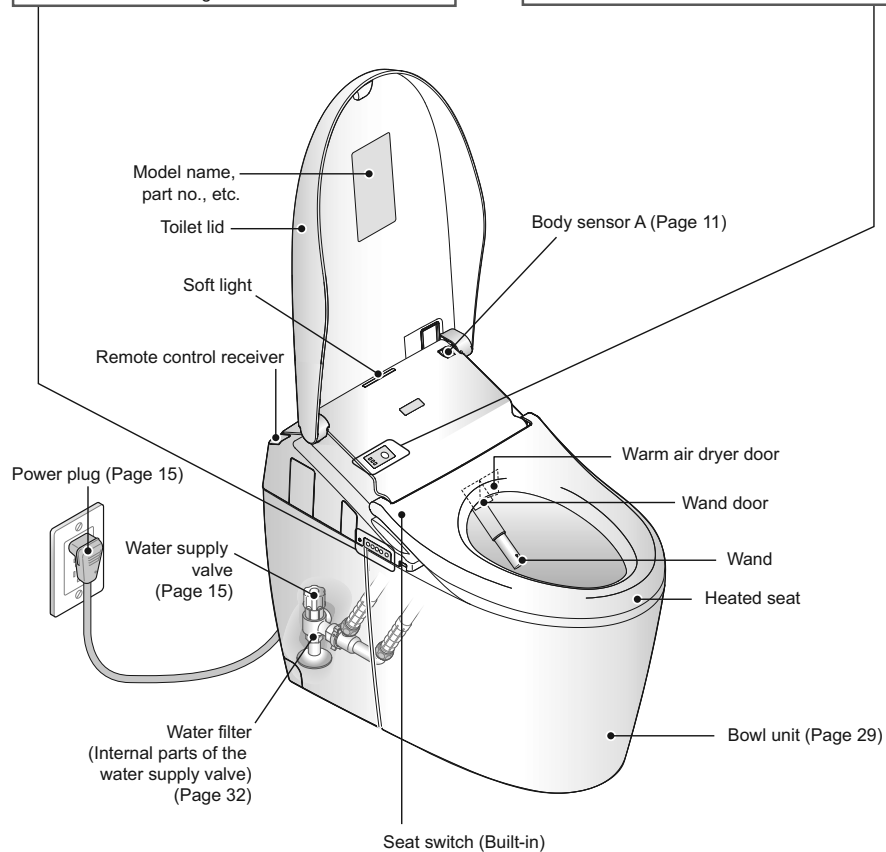
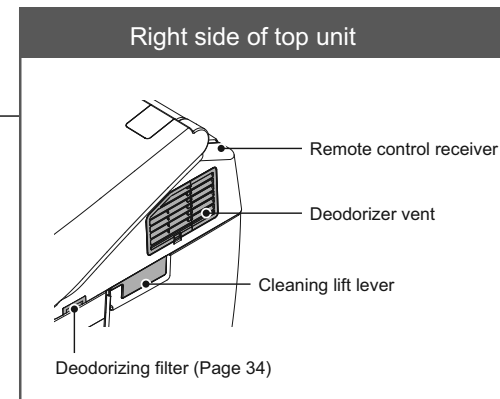
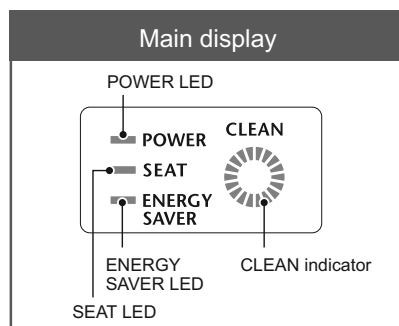
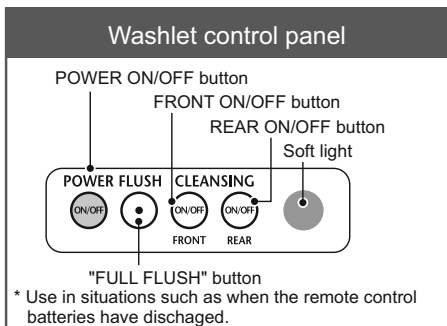

Preparation Using the Washlet for the First Time

1. Insert the battery.

- 1** Remove the remote control from the hanger.

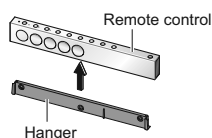

- 2** Open the battery cover and insert two AA batteries.

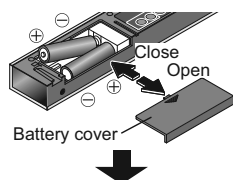

- When you set the batteries correctly in place, the following display lights up on the rear side of the remote control.

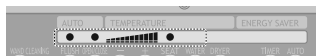

- 3** Mount the remote control in the hanger.

■ About the batteries

- Use dry cell, alkaline batteries. Follow the instructions below to prevent the batteries from rupturing or leaking fluid.
- When replacing the batteries, use new batteries of the same brand.
- If you will not be using the remote control for a long time, remove the batteries.
- Do not use rechargeable batteries.

When the remote control is locked to prevent theft

- 1** Remove the screws (2, left and right) from the remote control fixture.

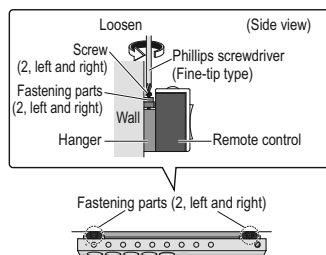

- 2** Remove the remote control from the hanger.

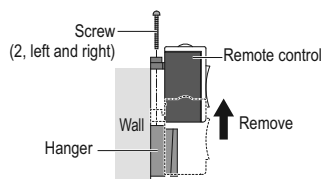

■ To return

- Tighten and fix the screws (2, left and right). (Overtightening may cause damage to parts such as the hanger)

2. Turn on the power.

- 1** [North, Central, South America]
Insert the power plug.

- The wand extends and then retracts.

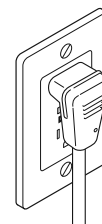

[Asia, Oceania, Middle East]

- Switch the breaker on the distribution board to ON.

- The wand extends and then retracts.

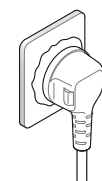

- 2** Check that the POWER LED on the main display of the Washlet is lit up.

- If it does not light up, press [POWER ON/OFF] to light it up.

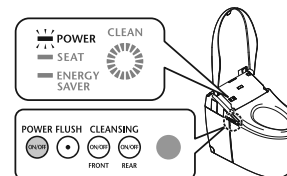

3. Open the water supply valve.

- 1** Remove the side panel.

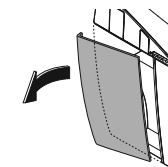

- 2** Fully open the water supply valve.

<For water supply from floor>

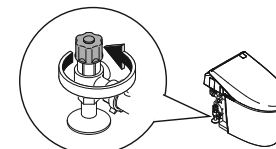

<For water supply from wall>

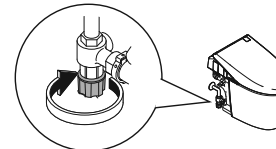

- 3** Reinstall the side panel.

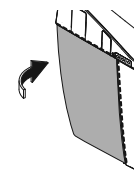

Basic Operations

Cleansing

[REAR CLEANSING] (Push the top side) : Cleanses your rear.
 [REAR SOFT] (Push the bottom side) : Cleanses your rear with a gentle water flow.

[FRONT CLEANSING] (Push the top side) : Serves as a bidet for women.
 [WIDE] (Push the bottom side) : Cleanses a wider area with the bidet.

Drying

[DRYER] : Dries your front and/or rear.

Stopping

[STOP] : Stops the operation.

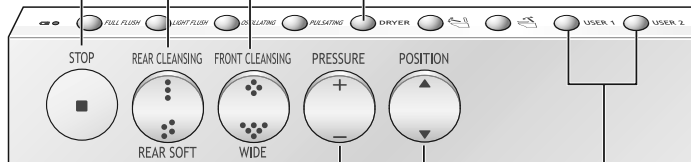

● Function that operate when a button is pressed during "REAR CLEANSING", "REAR SOFT", "FRONT CLEANSING" or "WIDE".

[PRESSURE]

- You can adjust the water pressure to one of five levels. ("+": Stronger, "-": Softer)
- When you press the flush button, the pressure returns to the default setting (pressure setting 3).
- If you do not want to return the wand to the default setting, refer to Page 50.

[POSITION]

- You can adjust the position to one of five positions.
- "▲" Moves to the front, "▼" Moves to the rear
- When you press the flush button, the position returns to the default position (position setting 3).
- If you do not want to return the wand to the default setting, refer to Page 50.

[OSCILLATING]

- When you press this button, the wand moves back and forth to wash you thoroughly.

[PULSATING]

- When you press this button, the wand cleanses with pulsation.

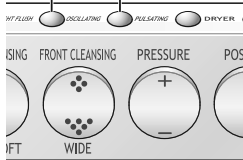

[PERSONAL SETTING LOCK 1]/ [PERSONAL SETTING LOCK 2]

You can store your preferred wand position, water pressure and water temperature settings.

- To store a setting
While cleansing is in progress, set your preferred wand position, water pressure, and warm water temperature, and then press and hold [USER 1] or [USER 2] for 2 seconds or longer.
- To use
After [USER 1] or [USER 2] is pressed, please push the button used for cleaning.

When flushing or opening/closing the toilet lid/seat with the remote control

Flush

[FULL FLUSH] : Perform a full flush.

[LIGHT FLUSH] : Perform a light flush.

Opening and closing

[SEAT OPEN/CLOSE] : Opens and closes the toilet seat.

[LID OPEN/CLOSE] : Opens and closes the lid.



Remote control backside

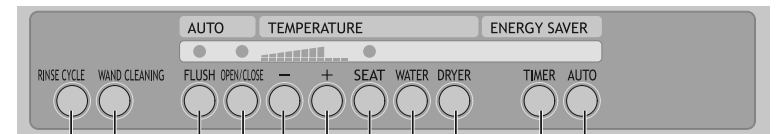

Cleaning features (Page 20)

AUTO features (Page 18)

Temperature feature selection (Page 22)

Energy-saver setting (Page 24)

Temperature adjustment (Page 22)



Automatic Functions Convenience Features

Various automatic functions are available, such as a toilet lid that opens and closes automatically.

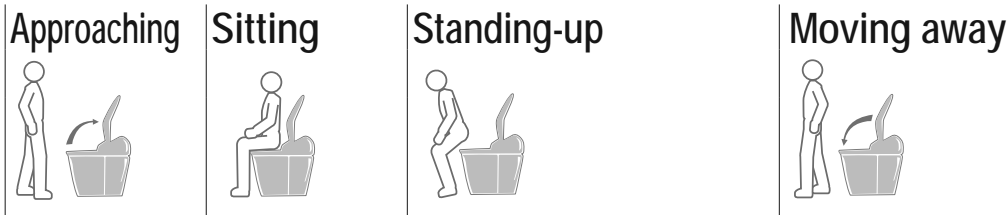



- Operation under the initial settings is described below.

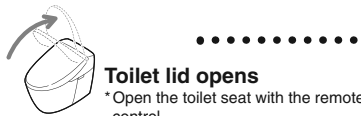

■ Note Changing settings

Flush automatically AUTO FLUSH	When sitting on the toilet  The toilet flushes. (After about 10 seconds)	Note <ul style="list-style-type: none"> • Auto bowl unit cleaning will be unavailable for about 60 seconds after flushing the toilet. (Operate with the remote control) • The flushing time varies depending on how long you sit on the toilet seat. Around 6 to 30 seconds: "LIGHT FLUSH" Around 30 seconds or more: "FULL FLUSH" • You must stand in front of the toilet bowl for 6 seconds or more to activate the auto flush. • When the tank is being replenished and an LED will flicker on the main display, you cannot flush the toilet even with the remote control. 	Changing settings <ul style="list-style-type: none"> • AUTO FLUSH ON/OFF • AUTO FLUSH WAITING TIME (→ Page 40)
	When standing in front of the toilet  The toilet flushes. (Using a "LIGHT FLUSH" about 3 seconds after the person has moved about 0.98 ft (about 30 cm) away from the toilet seat)		

Opening the toilet lid automatically AUTO OPEN/CLOSE	When using the toilet seat  Toilet lid opens	Toilet lid closes (About 90 seconds after you stand up from the toilet seat)	Note <ul style="list-style-type: none"> • When the room temperature reaches about 86°F (about 30°C) or higher, the sensor may not detect properly, preventing the toilet lid from opening. (Open and close with the remote control) • When the toilet lid is closed with the remote control or by hand, it cannot open automatically for about 15 seconds. (Open and close with the remote control) • If you sit on the toilet seat or stand in front of the bowl unit briefly, it will take about 5 minutes to close automatically. 	Changing settings <ul style="list-style-type: none"> • AUTO OPEN/CLOSE ON/OFF • Time until closing (→ Page 42) • Time until opening • Automatically opening both the toilet seat and toilet lid instead of just the lid (→ Page 44)
	When standing-up to urinate  Toilet lid opens * Open the toilet seat with the remote control.	The toilet lid and toilet seat close (About 90 seconds after moving away by about 0.98 ft (about 30 cm) or more)		

Lighting up the inside of the bathroom with a soft light SOFT LIGHT	Middle mode lights up 	High mode lights up 	Middle mode lights up (About 90 seconds after standing up) 	Low mode lights up (Goes out after about 5 seconds) 	Note <ul style="list-style-type: none"> • Soft light ON/OFF (→ Page 48)
---	---	---	---	--	---

Automatic Functions

Cleansing Features

"ewater+"* is used automatically to clean the wand and bowl unit.

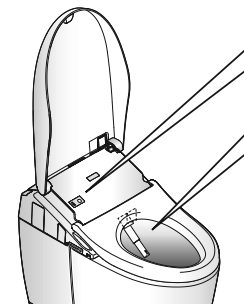
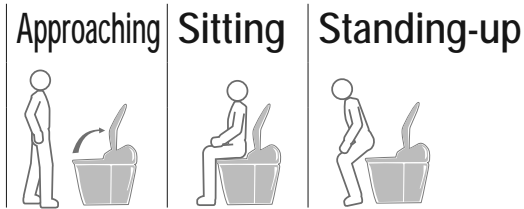

Support Cleaning

■ **Cleaning INDICATOR**
Lights to show that the "clean" functions are operating.

■ **BOWL LIGHT**
Lights to show that auto bowl cleaning and auto wand cleaning are operating.

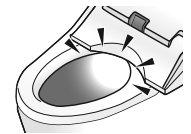

Note

Changing settings

<h3>DEODORIZER</h3>	<p>Starts the deodorizer</p>	<p>Deodorizer stops (After about 2 minutes)</p>	<ul style="list-style-type: none"> • Deodorizer ON/OFF (→ Page 46)
<p>Clean the wand automatically with clean and sterile water*</p> <h3>AUTO WAND CLEANING</h3>		<p>Cleans the wand automatically (After about 25 seconds, the wand extends and "ewater+"* comes out from the base of the wand) (Only when the cleansing functions are used)</p>	<ul style="list-style-type: none"> • When the wand has not been cleaned in 8 hours, the wand is cleaned automatically. (Water comes out from near the wand cover) • Auto wand cleaning ON/OFF (→ Page 46)
<p>Sanitize the bowl unit with "ewater+"*.</p> <h3>AUTO BOWL CLEANING</h3>	<p>Pre-mist (A mist is sprayed inside the bowl unit to make it more difficult for dirt to adhere)</p>	<p>After-mist (After the automatic wand cleaning is finished, "ewater+"* mist is sprayed inside the bowl unit)</p>	<ul style="list-style-type: none"> • The pre-mist and after-mist are not sprayed if the toilet seat is open. • The pre-mist is not sprayed for about 90 seconds after the after-mist has finished. • When the bowl has not been cleaned in 8 hours, the mist is sprayed inside the bowl unit automatically. • Auto bowl cleaning ON/OFF (→ Page 46)
<h3>BOWL LIGHT</h3>	<p>LED inside the bowl unit lights up during pre-mist</p>	<p>LED inside the bowl unit lights up during the auto wand cleaning and after-mist</p>	<ul style="list-style-type: none"> • Bowl LIGHT ON/OFF (→ Page 48)
<h3>INDICATOR</h3>	<p>CLEAN indicator lights up</p>	<p>CLEAN indicator lights up cyclically.</p>	<ul style="list-style-type: none"> • Lights up when "Auto wand cleaning", "Auto bowl cleaning" or "Deodorizer" is operating. (Only when sitting on the toilet seat) • CLEAN indicator ON/OFF (→ Page 48)

If dirt adheres...

- **If dirt adheres to the wand during use, you can extend the wand to clean it.**
 - Cleaning the wand (Page 35)
- **The bowl unit can be cleaned while the toilet is flushing.**
 - Cleaning the bowl unit (Page 29)

*What is meant by "ewater+" ?

This is a hypochlorous water that is generated from chloride ions in tap water via electrolysis (aka: electrolysed water or EO). It is widely used for cleaning and disinfecting items such as food, utensils and baby bottles.

- Well water may not deliver the required effect. (Because the level of chloride ions is low.)
- Clean, sterile water helps to minimize dirty surfaces, but does not make cleaning unnecessary.
- The effect and duration vary depending on the usage environment and conditions.

Temperature Adjustment Toilet Seat/Warm Water/Drying

1 Remove the remote control from the hanger.
If the remote control is locked to prevent theft (→ Page 12)

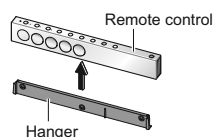

2 Press the button you want to adjust.

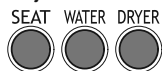

3 Select the temperature level.

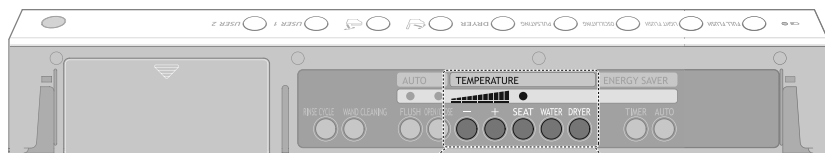
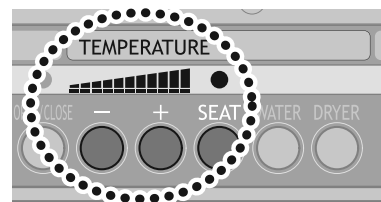
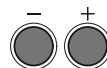

Remote control backside

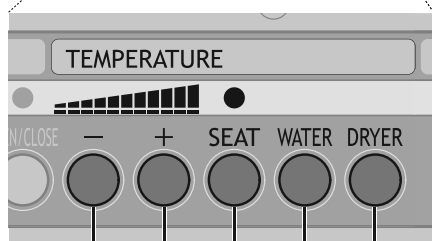

Temperature adjustment

[-] [+]

Temperature feature selection

[SEAT]
[WATER]
[DRYER]

Toilet seat temperature

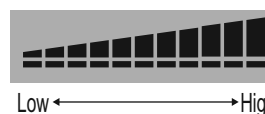

Off
- POWER
- SEAT
- ENERGY SAVER

■ When "OFF"



• When "OFF" is set, the SEAT LED will go off.

Water temperature

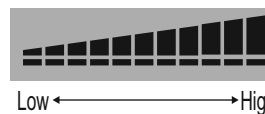

■ When "OFF"





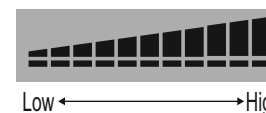



Drying air temperature

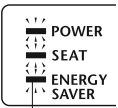
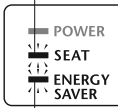

* To prevent condensation, the water temperature does not drop below 68°F (20°C) even when set to "OFF".

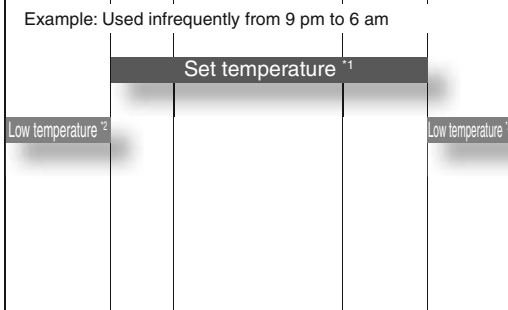
Energy-Saver Features Type

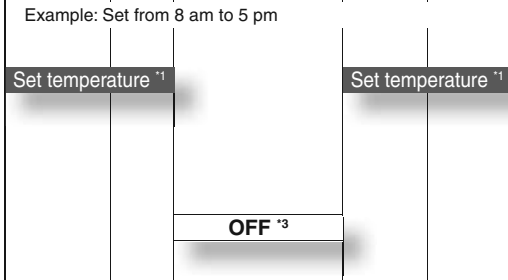
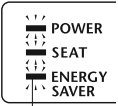
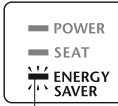
You can save energy by turning the toilet seat heater to a low temperature (or turning the heater "OFF") during periods when the toilet will be used infrequently.

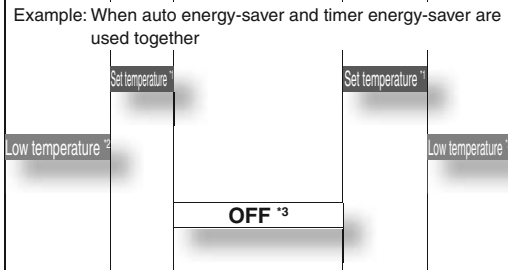
Type	Situation	Energy-Saver Status		Toilet seat heater	Time					
		Main display			AM	6	8	PM	5	9
Auto energy-saver	<p>You want to save energy but dislike a cold toilet seat</p> <p>The Washlet detects time periods with infrequent use and lowers the toilet seat temperature automatically.</p>	<p>When the energy-saver is set...</p>  <p>(Green)</p>	<p>When the energy-saver time arrives...</p>  <p>(Orange)</p>	 <p>Low</p>	<p>Example: Used infrequently from 9 pm to 6 am</p> 					
					 <p>OFF</p>	<p>Example: Set from 8 am to 5 pm</p> 				
Timer energy-saver	<p>You want to save energy only at the specified times</p> <p>When the desired time for saving energy is set, the heater is turned off automatically every day at this time.</p>	<p>When the energy-saver is set...</p>  <p>(Green)</p>	<p>When the energy-saver time arrives...</p>  <p>(Green)</p>	 <p>Low</p>  <p>OFF</p>		<p>Example: When auto energy-saver and timer energy-saver are used together</p> 				
Auto energy-saver + Timer energy-saver	<p>You want to save a lot of energy with auto energy-saver and timer energy-saver</p> <p>When both auto energy-saver and timer energy-saver are set, auto energy-saver operates when timer energy-saver is not operating.</p>	<p>When the energy-saver is set... When the energy-saver time arrives...</p> <ul style="list-style-type: none"> ● During auto energy-saver: Same LED indication as auto energy-saver (see above) ● During timer energy-saver: Same LED indication as timer energy-saver (see above) 								

Operation

- Note**
- Even if the toilet seat heater is set to "Low" or "OFF", the toilet seat is temporarily heated when you sit on it.
 - Auto energy-saver takes about 10 days to detect time periods in which the toilet seat is never or infrequently used.

*1 The toilet seat temperature set on page 22.

*2 The time period when the toilet seat heater is set to a low temperature by the auto energy-saver.

*3 The time period when the toilet seat heater is "OFF".

To set energy-saver Pages 26 and 27

Energy-Saver Features How to Set

Remote control backside

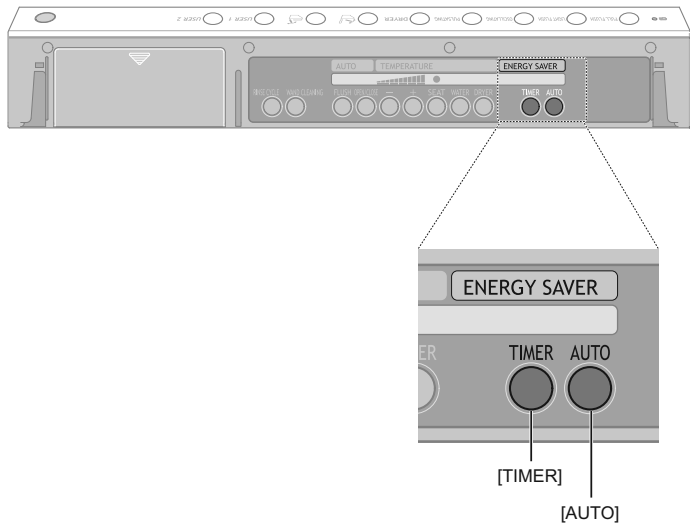

When energy-saver is set, the ENERGY SAVER LED (green) lights up.

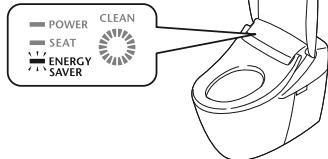

Auto energy-saver

1 Press [AUTO].

■ To stop auto energy-saver

Press [AUTO] again.



Timer energy-saver

Example: To save energy from 1 am to 7 am (for 6 hours)

1 At 1am, press [TIMER] repeatedly until "6" is displayed.

■ To change the energy saver time

Press [TIMER] repeatedly until you have the time period.

● You can set to 3, 6, or 9 hours.

■ When not using the timer energy-saver feature

Repeatedly press [TIMER] until the display goes out.

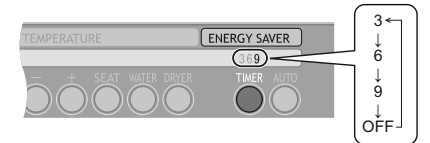

Auto energy-saver + Timer energy-saver

■ This sets auto energy-saver (with the procedure above).

■ This sets timer energy-saver (with the procedure above).

● It does not matter which feature is set first.



Maintenance Power plug

Power Plug (Perform monthly) <North, Central, South America>



Dry cloth

Wet cloth

- 1 Disconnect the power plug and wipe it with a dry cloth.

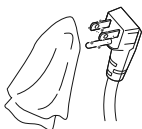

- 2 Insert the power plug.

⚠ WARNING



- Periodically remove dust from the blades and other parts of the power plug.

- Disconnect the plug and wipe it with a dry cloth.



- Fully insert the power plug.
- When disconnecting, hold the main body of the power plug.
- Pulling by the cord may damage the plug or cord.

Do not use a dry cloth or toilet paper on plastic parts. (May cause damage)

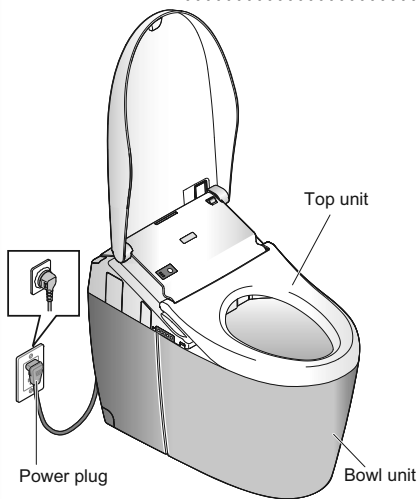
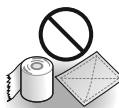

Power plug

Top unit

Bowl unit

^[North, Central, South America]
For safety, disconnect the power plug before cleaning.

^[Asia, Oceania, Middle East]
Switch the breaker on the distribution board to OFF before cleaning or maintenance.

- * Except when using "Wand cleaning" or "Bowl unit cleaning".
- * ^[North, Central, South America] After the power plug is inserted, the toilet lid will not open automatically for about 10 to 60 seconds. (Because it is preparing for operation) Open/close the toilet lid with the remote control.
- * ^[Asia, Oceania, Middle East] After the distribution board breaker is switched to ON, the toilet lid will not open automatically for about 10 to 60 seconds. (Because it is preparing for operation) Open/close the toilet with the remote control.

Maintenance Top Unit/Bowl Unit

Top Unit (Perform monthly)

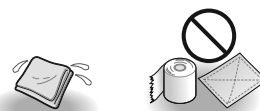

Wet cloth

Toilet paper, etc. (May cause damage)

- 1 ^[North, Central, South America] Unplug the power plug. ^[Asia, Oceania, Middle East] Switch the breaker on the distribution board to OFF.

- 2 Wipe with a soft cloth that has been soaked in water and wrung-out thoroughly.

■ For heavy dirt

- Wipe with a soft cloth soaked in diluted, neutral kitchen detergent. Then, wipe with a soft cloth soaked in water.

- 3 ^[North, Central, South America] Insert the power plug. ^[Asia, Oceania, Middle East] Switch the breaker on the distribution board to ON.

Attention!

- The Washlet is an electric appliance. Be careful not to allow water to get inside or leave detergent in the gap between the top unit and the bowl unit.
- Do not push or pull the wand door or the warm air dryer door with undue force. (May cause damage or malfunctions)

Bowl Unit (Perform daily)



Toilet brush
Toilet detergent



Strongly acidic cleaners or strong alkaline cleaners
Cleaners containing abrasive compounds
Wire brush
Abrasive nylon scrubbing brush

- 1 ^[North, Central, South America] Unplug the power plug. ^[Asia, Oceania, Middle East] Switch the breaker on the distribution board to OFF.

- 2 Clean with a toilet brush or a similar tool. ■ The bowl unit can be cleaned while the toilet is flushing. (Insert the power plug or switch the breaker on the distribution board to ON)

<Bowl unit cleaning>

Press [RINSE CYCLE] (backside of remote control, Page 17)

- The toilet flushes (for about 30 seconds).
- Clean inside the bowl unit.
- The water in the bowl unit is drained and the water level drops (for about 30 seconds).
- The water in the bowl unit is drained and the water returns to its original level.

- To stop part way through, Press [STOP].

■ If the bowl unit is clogged

- Use commercially available tools that are made for unclogging toilets



■ If the floor is dirty

- Clean it with a well rung mop (not cleaning the floor may stain the product or cause it to corrode)
- The splashing of urine from standing urination can be reduced by sitting down.

- 3 ^[North, Central, South America] Insert the power plug. ^[Asia, Oceania, Middle East] Switch the breaker on the distribution board to ON.

Attention!

- Do not use any water repellent, stain-proofing cleaner or surface coating agent. These products would not damage the porcelain surface, but they may cover the porcelain surface and reduce the effect of the built-in stain prevention technology.

Maintenance Gap between the Top Unit and Bowl Unit

Gap between the Top Unit and Bowl Unit (Perform monthly)

You can lift up the top unit with the cleaning lift lever and clean the gap between it and the bowl unit.

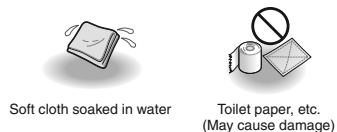

- 1 [North, Central, South America] Unplug the power plug.
[Asia, Oceania, Middle East] Switch the breaker on the distribution board to OFF.

- 2 Open the toilet seat and lid.

- 3 Pull the cleaning lift lever until you cannot pull it out any more, then turn it downward.

(This raises the front side of the top unit about 0.08 ft (about 25 mm))

- 4 Clean the gap.

- Wipe with a soft cloth soaked in a diluted, neutral kitchen detergent. Then, wipe it with a soft cloth soaked in water so that no detergent remains.

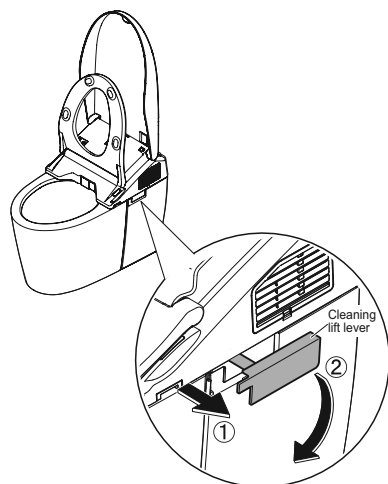
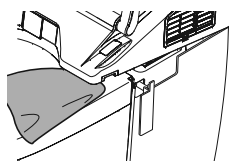

- 5 Pull the cleaning lift lever until you cannot pull it out any more, then turn it upward.

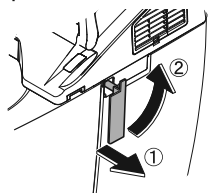

- 6 [North, Central, South America] Insert the power plug.
[Asia, Oceania, Middle East] Switch the breaker on the distribution board to ON.

CAUTION



When operating the cleaning lift lever

- Do not put a finger between the top unit and bowl unit.
- Do not use the product while the top unit is lifted up.

Attention!

- Do not directly spray cleaner and water.
- Do not force the cleaning lift lever.
- Do not force the toilet seat or lid to move while the top unit is raised up.

Maintenance Gap between the Top Unit and Toilet Lid

Between the top unit and the toilet lid (Perform monthly)

The toilet lid can be removed for thorough cleaning.

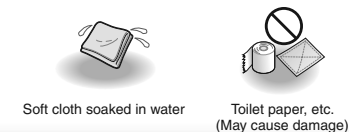

- 1 [North, Central, South America] Unplug the power plug.
[Asia, Oceania, Middle East] Switch the breaker on the distribution board to OFF.

- 2 Remove the toilet lid.
Pull straight up strongly in the following order show in the diagram to the right: A → B.

- 3 Wipe with a soft cloth that has been soaked in water and then wrung out thoroughly.

- 4 Reinstall the toilet lid.
Insert the toilet lid pins in the following order show in the diagram to the right: C → D.

* Do not insert the pins at a slant or using excessive force.

- 5 [North, Central, South America] Insert the power plug.

[Asia, Oceania, Middle East] Switch the breaker on the distribution board to ON.

- 6 Open and close the toilet lid to check the reinstallation.

Removing and Reinstalling

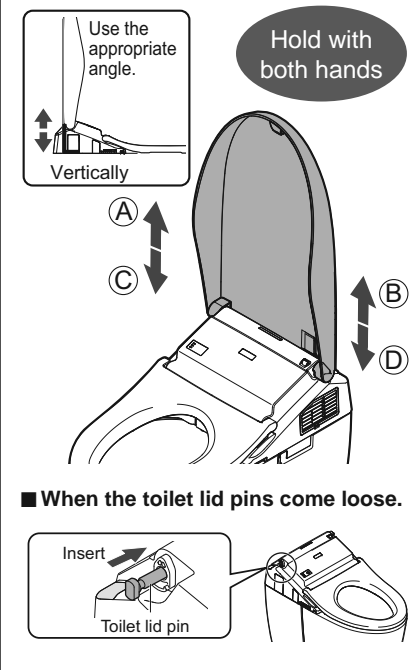

When the toilet lid pins come loose.

Maintenance

Water Filter Drain Valve

Water Filter Drain Valve (Perform once every 6 months)
 <If you think the water pressure has weakened>

CAUTION

 **Do not remove the water filter drain valve while the water supply valve is open.**
 (Otherwise, water may leak out)

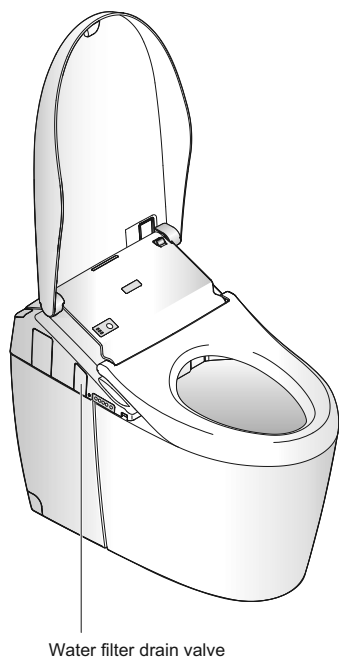

1 Close the water supply valve. (Page 55)
 • The water supply stops.

2 Release the pressure from the water supply pipe.
 1. Remove the remote control from the hanger, then press [WAND CLEANING] on the backside to extend the wand. (Page 17)
 Press [WAND CLEANING] again to retract the wand.

3 Remove the cover.

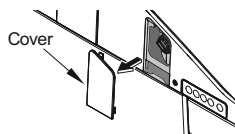

4 [North, Central, South America]
 Unplug the power plug.
 [Asia, Oceania, Middle East]
 Switch the breaker on the distribution board to OFF.

5 Remove the water filter drain valve.
 • Loosen with a flat-head screwdriver and then pull.

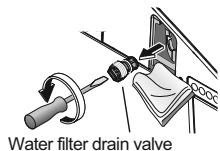

6 Clean with a tool such as a toothbrush.
 Also, remove any dust from inside the hole of the drain valve.

7 Reinstall the water filter drain valve.
 • Insert the drain valve and use a flat-head screwdriver to tighten it securely.

8 Reinstall the cover.

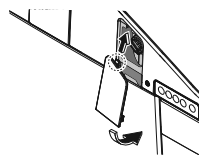

9 [North, Central, South America] Insert the power plug.
 [Asia, Oceania, Middle East] Switch the breaker on the distribution board to ON.

10 Open the water supply valve.
 (Page 15)

Maintenance Deodorizing filter

Deodorizing Filter (Perform monthly)

<If you notice odors>

- 1** [North, Central, South America]
Unplug the power plug.
 [Asia, Oceania, Middle East]
Switch the breaker on the distribution board to OFF.
- 2** **Remove the deodorizing filter.**

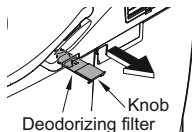
 - Hold the knob and pull outward.
 - Do not pull with undue force. (May cause damage or malfunctions)
- 3** **Clean with a tool such as a toothbrush.**

 - When washing with water, dry off all water before mounting.
- 4** **Mount the deodorizing filter.**

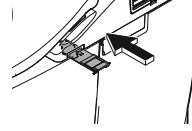
 - Push firmly until a click sound is heard.
- 5** [North, Central, South America]
Insert the power plug.
 [Asia, Oceania, Middle East]
Switch the breaker on the distribution board to ON.

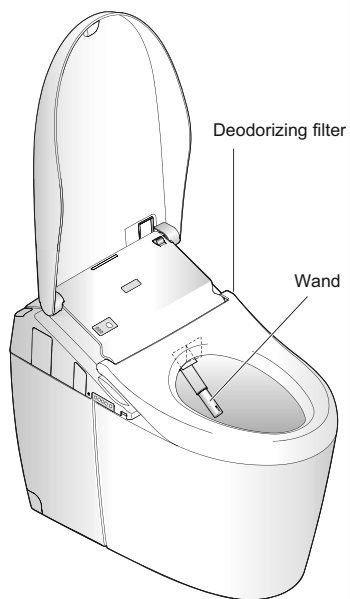

Wand

Wand (Perform monthly)

<Wand cleaning> If you notice dirt

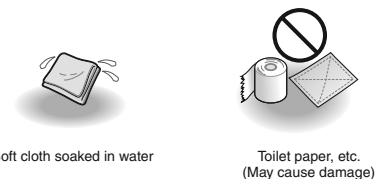

- 1** **Extend the wand.**

1. Remove the remote control from the hanger, then press [WAND CLEANING] on the backside of the remote control. (Page 17)

 - The wand extends and water dribbles out for cleaning.
 - The wand automatically retracts after about 5 minutes.
- 2** **Wipe with a soft, wet cloth.**

 - Do not pull, push or press the wand with excessive force.
(May cause damage or malfunctions.)
- 3** **Retract the wand.**

1. Press [WAND CLEANING] again to retract the wand.

 - The wand retracts.

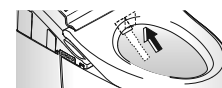
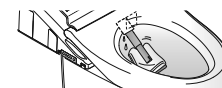

Maintenance Water filter (Bowl unit)

Water Filter (Bowl Unit) (Perform once every 6 months)

- 1** Remove the side panel (left).

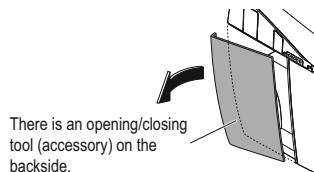

- 2** Close the water supply valve.
(Page 55)

CAUTION

Do not remove the water filter drain valve while the water supply valve is open.
(Otherwise, water may spray out)

- 3** Remove the remote control from the hanger, then press [WAND CLEANING] on the backside of the remote to extend the wand. (Page 17)
Press [WAND CLEANING] again to retract the wand.
(For releasing the pressure inside the water pipes.)

- 4** [North, Central, South America]
Unplug the power plug.
[Asia, Oceania, Middle East]
Switch the breaker on the distribution board to OFF.

- 5** Loosen the nut on the water supply valve to remove the water filter.
• Use the opening/closing tool (accessory) on the backside of the side panel (left).

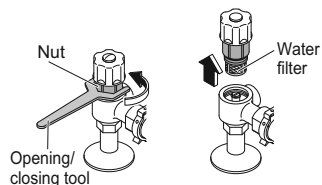

- 6** Remove the water filter and clean with a toothbrush or similar instrument.
• Do not use detergent
• Do not apply excessive force to the water filter (could cause deformation)
• Replace the filter when it is very dirty or clogged.

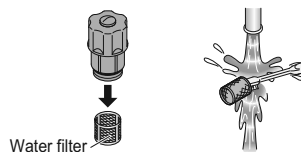

- 7** Insert the water filter into the nut and insert the nut into the water supply valve.

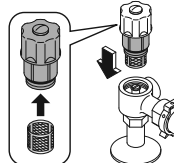

- 8** Tighten the nut on the water supply valve.

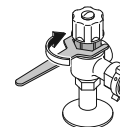

- 9** Open the water supply valve
(Page 15).
• Check that there are no leaks in the water supply valve or plumbing connections.

- 10** Mount the opening/closing tool to its original position and reinstall the side panel.

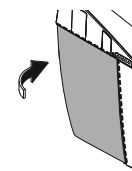

- 11** [North, Central, South America]
Insert the power plug.
[Asia, Oceania, Middle East]
Switch the breaker on the distribution board to ON.

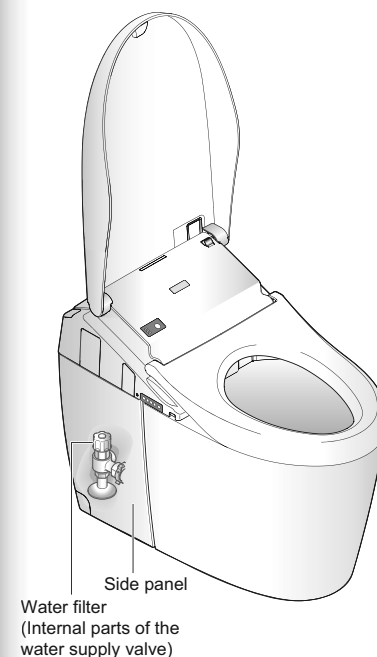

Changing Settings Setting List

Various settings can be configured to make the Washlet more convenient and user-friendly for you and your family.

Setting Types			Available Settings*	Setting Ref. Page	
AUTO FUNCTIONS	AUTO FLUSH	AUTO FLUSH	• Set whether or not to clean the bowl unit automatically	ON/OFF	Page 40
		AUTO FLUSH WAITING TIME	• Change the amount of time before the toilet flushes automatically.	5 SEC/10 SEC/15 SEC	
	AUTO OPEN/CLOSE	AUTO OPEN/CLOSE	• Set whether or not to open the toilet lid automatically	ON/OFF	Page 42
		AUTO CLOSE WAITING TIME	• Change the amount of time before the lid/ seat closes automatically.	90SEC/25SEC	
		AUTO OPEN WAITING TIME	• Change the amount of time before the lid/ seat opens automatically after it has been closed manually with the remote control.	15SEC/30SEC/90SEC	Page 44
		SEAT/LID	• Automatically open and close the toilet lid only/Automatically open and close the toilet seat and toilet lid.	LID/SEAT•LID	
	CLEANING	AUTO WAND CLEANING	• Set whether or not to clean the wand automatically	ON/OFF	Page 46
		AUTO BOWL CLEANING	• Set whether or not to spray mist in the bowl unit automatically.	ON/OFF	
		DEODORIZER	• Set whether or not to deodorize automatically after sitting on the toilet seat	ON/OFF	
	LIGHT	SOFT LIGHT	• Set whether or not to use the soft light	ON/OFF	Page 48
		BOWL LIGHT	• Set whether or not to use the light inside the bowl unit	ON/OFF	
		INDICATOR	• Set whether or not to light up the CLEAN indicator	ON/OFF	
OTHER SETTINGS	ANTI-FREEZING (TCF9786JA only)		• Set whether or not to run the water for the bowl unit and wand automatically at a fixed interval in order to prevent freezing (dynamic mode Page 54)	ON/OFF	Page 50
	BEEP		• Set whether or not to make a beep sound	ON/OFF	
	PRESSURE/POSITION SETTING		• Set whether or not to keep your favorite pressure and position settings	ON/OFF	
	PERSONAL SETTING LOCK		• Set whether or not to use the personal setting lock	ON/OFF	

* The black text is the initial setting.

Changing Settings

AUTO FLUSH

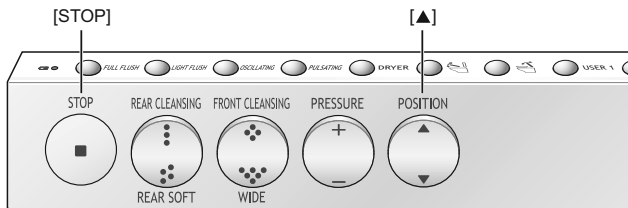

Remote control backside

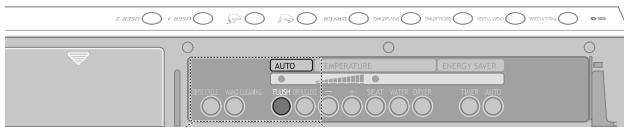

[FLUSH]

Set whether or not to flush the bowl unit automatically

AUTO FLUSH

1 Press [FLUSH].



The setting changes each time the button is pressed

- **For flushing automatically**
"●" is displayed on the remote control display panel.
- **For not flushing automatically**
"●" is not displayed on the remote control display panel.

Change the amount of time before the toilet flushes automatically

AUTO FLUSH WAITING TIME

● You can set the waiting time before automatic flushing after use to about 5, 10, or 15 seconds.

1 Hold down [STOP], for about 10 seconds, until the entire display panel on the backside of the remote control flashes.



2 Press [POSITION ▲].

3 Press [STOP].
<Settings complete>

The setting changes each time the button is pressed

- **For setting a waiting time to about 5 seconds**
You will hear two short beeps.
- **For setting a waiting time to about 10 seconds**
You will hear one long beep.
- **For setting a waiting time to about 15 seconds**
You will hear one short beep.

Changing Settings

AUTO OPEN / CLOSE

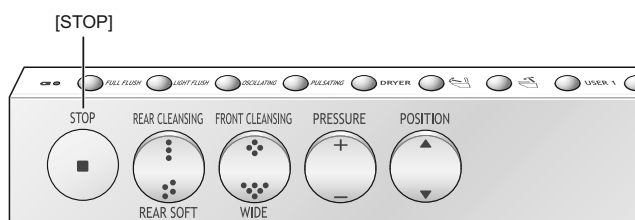

Remote control backside

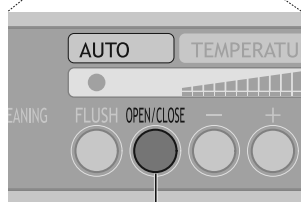
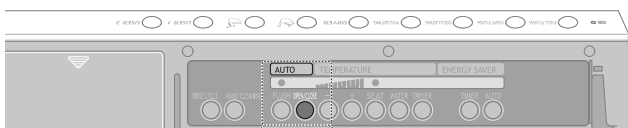

[OPEN/CLOSE]

Set whether or not to open the toilet lid automatically

AUTO OPEN/ CLOSE

1 OPEN/CLOSE

Press [OPEN/CLOSE].



The setting changes each time the button is pressed

- **For opening/closing automatically**
"●" is displayed on the remote control display panel.
- **For not opening/closing automatically**
"●" is not displayed on the remote control display panel.

Change the time period till automatic closing

AUTO CLOSE WAITING TIME

1 STOP

Hold down [STOP], for about 10 seconds, until the entire display panel on the backside of the remote control flashes.

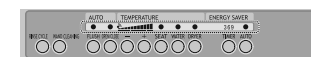

2 OPEN/CLOSE

Hold down [OPEN/CLOSE] for 5 seconds or longer.

3 STOP

Press [STOP].
<Settings complete>

The setting changes each time the button is held down longer than 5 seconds.

- **For setting a waiting time to about 90 seconds**
You will hear one long beep.
- **For setting a waiting time to about 25 seconds**
You will hear one short beep.

Changing Settings

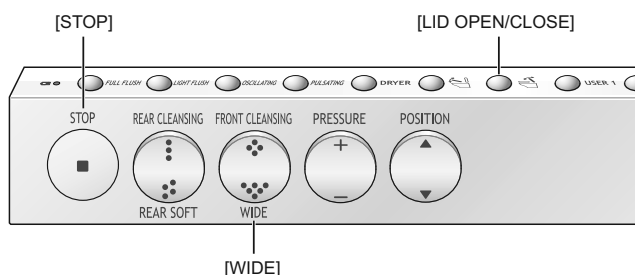

AUTO OPEN / CLOSE



Change the time period till automatic opening
(After closing manually or with the remote control.)

AUTO OPEN WAITING TIME

- You can set the waiting time for auto opening after the toilet lid is closed manually or with the remote control to about 15, 30, or 90 seconds.

-  Hold down [STOP], for about 10 seconds, until the entire display panel on the backside of the remote control flashes.
-  Press [WIDE].
-  Press [STOP].
<Settings complete>

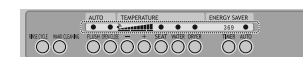



The setting changes each time the button is pressed

- **For setting a waiting time to about 15 seconds**
You will hear one long beep.
- **For setting a waiting time to about 30 seconds**
You will hear one short beep.
- **For setting a waiting time to about 90 seconds**
You will here two short beeps.

Automatically open and close the toilet lid only/Automatically open and close the toilet lid and seat

SEAT/LID

- Set "AUTO OPEN/CLOSE".

-  Hold down [STOP], for about 10 seconds, until the entire display panel on the backside of the remote control flashes.
-  Press [LID OPEN/CLOSE].
-  Press [STOP].
<Settings complete>

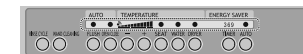

The setting changes each time the button is pressed

- **For opening the toilet lid automatically**
You will hear one long beep.
- **For opening both the toilet lid and toilet seat automatically**
You will hear one short beep.

Changing Settings

CLEANING

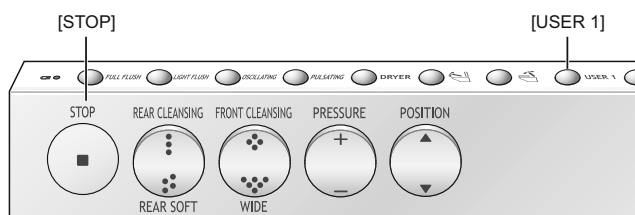

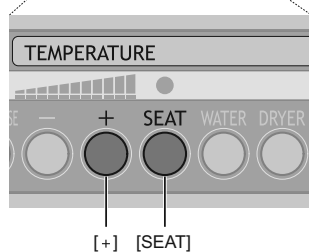
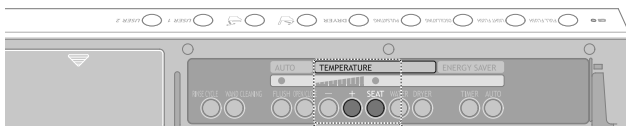

Remote control backside



Set whether or not to clean the wand automatically

AUTO WAND CLEANING

- 1  Hold down [STOP], for about 10 seconds, until the entire display panel on the backside of the remote control flashes.
- 2  Press [SEAT].
- 3  Press [STOP].
<Settings complete>

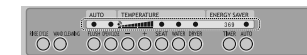



The setting changes each time the button is pressed

- For setting to "ON"
You will hear one short beep.
- For setting to "OFF"
You will hear one long beep.

Set whether or not to spray mist in the bowl unit automatically

AUTO BOWL CLEANING

- 1  Hold down [STOP], for about 10 seconds, until the entire display panel on the backside of the remote control flashes.
- 2  Press [+].
- 3  Press [STOP].
<Settings complete>

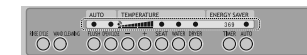



The setting changes each time the button is pressed

- For setting to "spray"
You will hear one short beep.
- For setting to "do not spray"
You will hear one long beep.

Set whether or not to deodorize automatically after sitting on the toilet seat

DEODORIZER

- 1  Hold down [STOP], for about 10 seconds, until the entire display panel on the backside of the remote control flashes.
- 2  Press [USER 1].
- 3  Press [STOP].
<Settings complete>

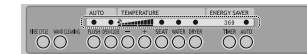

The setting changes each time the button is pressed

- For setting to "ON"
You will hear one short beep.
- For setting to "OFF"
You will hear one long beep.

Changing Settings

LIGHT

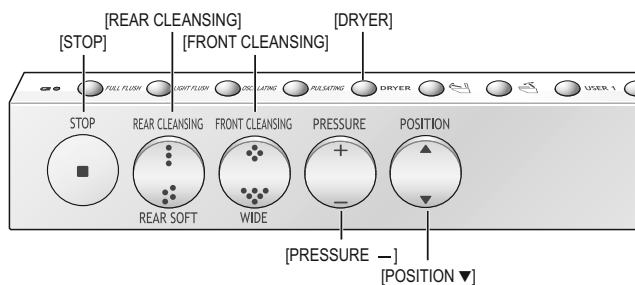

Set whether or not to use the soft light
SOFT LIGHT

1 Hold down [STOP], for about 10 seconds, until the entire display panel on the backside of the remote control flashes.

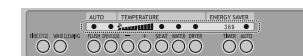

2 Press [DRYER].

The setting changes each time the button is pressed

- For setting to "use"
You will hear one short beep.
- For setting to "do not use"
You will hear one long beep.

3 Press [STOP].
<Settings complete>

Set whether or not to use the light inside the bowl unit
BOWL LIGHT

1 Hold down [STOP], for about 10 seconds, until the entire display panel on the backside of the remote control flashes.

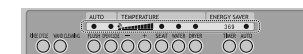

2 Press [PRESSURE +] and [POSITION ▲] at the same time.

The setting changes each time the button is pressed

- For setting to "use"
You will hear one short beep.
- For setting to "do not use"
You will hear one long beep.

3 Press [STOP].
<Settings complete>

Set whether or not to light up the CLEAN indicator
INDICATOR

1 Hold down [STOP], for about 10 seconds, until the entire display panel on the backside of the remote control flashes.



2 Press [REAR CLEANSING] and [FRONT CLEANSING] at the same time.

The setting changes each time the button is pressed

- For setting to "light up"
You will hear one short beep.
- For setting to "do not light up"
You will hear one long beep.

3 Press [STOP].
<Settings complete>

Changing Settings

Other settings

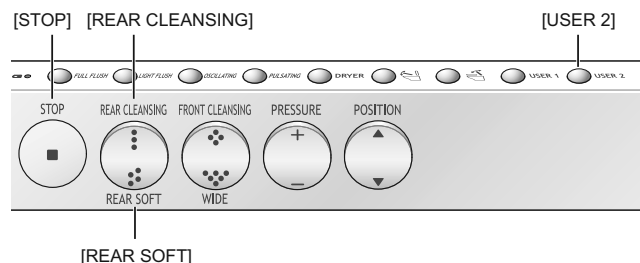

Remote control backside

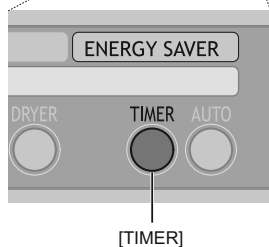
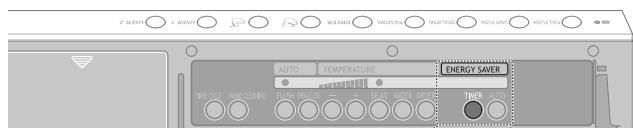

[TIMER]

Set whether or not runs the water for the bowl unit and wand automatically at a fixed interval to prevent freezing

ANTI-FREEZING (TCF9786JA only)

- 1 Hold down [STOP], for about 10 seconds, until the entire display panel on the backside of the remote control flashes.
- 2 Press [TIMER].
- 3 Press [STOP].
<Settings complete>

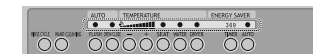

The setting changes each time the button is pressed

- For setting to "ON"
You will hear one short beep.
- For setting to "OFF"
You will hear one long beep.

Set whether or not to make a beep sound

BEEP

- 1 Hold down [STOP], for about 10 seconds, until the entire display panel on the backside of the remote control flashes.
- 2 Hold down [REAR CLEANSING] for 5 seconds or longer.
- 3 Press [STOP].
<Settings complete>

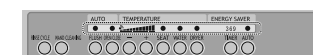

The setting changes each time the button is held down longer than 5 seconds.

- For making a beep sound
You will hear one short beep.
- For not making a beep sound
You will hear one long beep.

Set to keep your favorite pressure and position settings for future use

PRESSURE/ POSITION SETTING

- 1 Hold down [STOP], for about 10 seconds, until the entire display panel on the backside of the remote control flashes.
- 2 Hold down [REAR SOFT] for 5 seconds or longer.
- 3 Press [STOP].
<Settings complete>

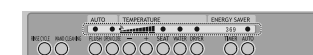

- For returning to the standard position
Repeat operations 1 - 3.

Set whether or not to use the personal setting lock

PERSONAL SETTING LOCK

- 1 Hold down [STOP], for about 10 seconds, until the entire display panel on the backside of the remote control flashes.
- 2 Hold down [USER 2] for 5 seconds or longer.
- 3 Press [STOP].
<Settings complete>



- For returning to the standard position
Repeat operations 1 - 3.

What to Do?

If there is no water due to a power outage or water failure

- 1 Use a bucket to flush water.
- 2 If the water level is low after flushing, add more water.
 - Prevents odors.

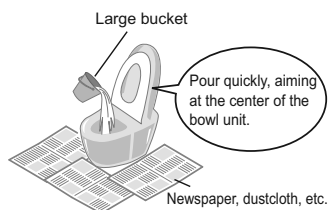

Attention!

- If there is a water supply failure, set the auto bowl unit cleaning to "OFF".

If you cannot operate with the remote control

■ Operation is also possible using the buttons on the Washlet control panel.

● If the Low Battery Warning LED is flashing, replace the batteries. (Page 14)

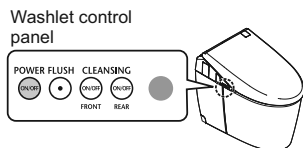

■ Replacing the batteries

- 1 Press [POWER ON/OFF] on the Washlet control panel.
 - The POWER LED goes off.
- 2 Remove the remote control from the hanger. (Page 14)
- 3 Open the cover and replace the AA batteries. (Page 14)
- 4 Mount the remote control in the hanger.
- 5 Press [POWER ON/OFF] on the Washlet control panel.
 - The POWER LED lights up.

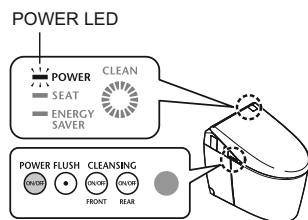

Note

- When the battery is replaced, the timer energy-saver, auto bowl unit flush, and other settings may be returned to their default values. If this happens, please set them again.

Long Periods of Disuse

If you will be absent from home for a long time in the winter, be sure to drain the water to prevent freezing.

Also, if the toilet is in a location you will not visit for a long time, drain the water.

(The water in the tank may become contaminated and cause skin inflammation or other problems)

- Before draining the water, check that the top unit is not lifted up and that the cleaning lift lever (Page 30) is retracted to its original position.

How to drain the water

- 1 Close the water supply valve. (Page 55)
- 2 Drain the pipe.
 - ① Remove the remote control from the hanger, then press [WAND CLEANING] on the backside of the remote control to extend the wand. Press [WAND CLEANING] again to retract the wand. (Page 17)
(For releasing the pressure from the water supply pipe)
 - ② Remove the cover.
 - ③ Remove the water filter drain valve.
 - Water filter drain valve
 - Flat-head screwdriver
 - ④ After draining the water, mount the water filter drain valve.
 - Tighten it securely using a flat-head screwdriver.
 - ⑤ Reinstall the cover.
- 3 Pull out the water drain lever.
 - The water comes out from near the wand for about 20 seconds.
- 4 Release your hand to return the water drain lever to its original position.
- 5 Drain the water from inside the toilet tank.
 - See the "Tank draining procedure" label on the backside of the side panel (left).
- 6 [North, Central, South America] Unplug the power plug. [Asia, Oceania, Middle East] Switch the breaker on the distribution board to OFF.
- 7 Take appropriate measures for the water remaining in the bowl unit.
 - Putting antifreeze in the water remaining in the bowl unit will reduce its chances of freezing.

■ To use the Washlet again

- The water needs to be resupplied. (Page 54)

What to Do? Freeze Damage Prevention TCF9786JA only

In preparation for freezing conditions, such as in wintertime, take measures to prevent freezing.

Attention!

- Do not use the energy-saver feature if there is a risk of the product being exposed to freezing temperatures. (The product may be damaged)
- Warm the bathroom so that the temperature around the product is not below freezing or take other appropriate measures against freezing temperatures.
- Before starting work, set "AUTO FLUSH"(Page 40) and "AUTO OPEN/CLOSE" (Page 42) to "OFF".

Dynamic mode

This method runs the water for the bowl unit and wand automatically at a fixed interval in order to prevent freezing.

How to set (Page 50)

- Switch ANTI-FREEZING to ON with the remote control. (Flashing: green)

While ANTI-FREEZING is set to ON, it works as follows.

- The POWER LED flashes.
- The toilet flushes at intervals of about 10 minutes.
- About 0.013 gal (about 50 ml) of water comes out from near the wand at intervals of 5 minutes. (The wand remains retracted.)

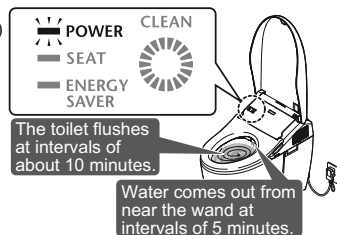

Resupplying the Water (After draining)

- 1** Open the water supply valve to supply water.
 - Check that there are no leaks in the plumbing or the Washlet.
- 2** [North, Central, South America]
If the power plug is disconnected, insert it.
[Asia, Oceania, Middle East]
If the breaker on the distribution board is set to OFF, switch it to ON.
- 3** Discharge water from the wand.
 1. Press down the left side of the toilet seat.
 2. Press the "REAR CLEANSING" button on the remote control to discharge water from the wand. (Catch the water in a paper cup or other receptacle)
 - If the remaining water has frozen and no water comes out
 - Heat the inside of the bathroom, and warm the water supply hose and water supply valve using a cloth soaked in warm water.
- 4** Press [FULL FLUSH] on the remote control to flush.
 - If there is no water in the tank, you cannot flush the toilet. Never operate the toilet with no water in the tank.
 - When the tank is filling with water, the LEDs on the main display will flash. When the tank becomes full, the light remains to ON continuously. (Tank filling time: approx. 30 seconds)
- 5** After the bowl unit fills with water, press [FULL FLUSH] again.

Troubleshooting

First, try the actions described on pages 56 to 61. If the problem persists, consult the installer, seller or the contact listed on the back cover of this manual.

If the CLEAN indicator no longer lights up...

- Consult with the contact referred on the back cover of this manual.

If all LEDs are flickering:

- Consult with the contact referred on the back cover of this manual.

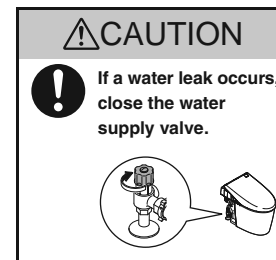
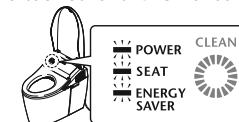

Please check first

Is the POWER LED lit?

- Does the LED light up when you press [POWER ON/OFF] on the top unit?

- Is the breaker on the distribution board turned on?

- Check whether there is a power outage or the breaker has turned "OFF".

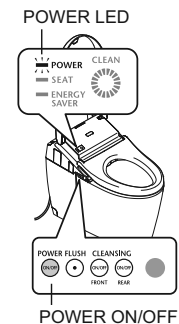

Is the ENERGY SAVER LED lit?

- While the LED is lit, energy-saver (Page 24) is in operation, so the toilet seat temperature may be reduced or the heater may be turned off.

Is the remote control working?

- Is the Low Battery Warning LED on the top surface of the remote control flashing?

- Replace the batteries. (Pages 14, 52)

- Is the remote control transmitter or the top unit receiver blocked?

- Remove obstructions, dirt, water droplets or any other blockages.

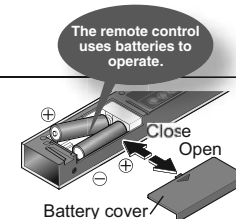

Remote control transmitter

Top unit receiver

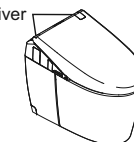
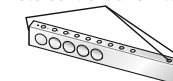

Troubleshooting

Rear and Front Cleansing		
Trouble	Please check	Ref. Page
The wand does not extend.	<ul style="list-style-type: none"> Can you operate with the Washlet control panel? (Check while sitting on the toilet seat.) →Check "Is the remote control working?" 	55
	<ul style="list-style-type: none"> When the temperature is low, it takes time for the wand to come out after the button on the remote control is pressed because the water must be warmed up. 	—
	<ul style="list-style-type: none"> Did you sit on the toilet continuously for 2 hours or longer? (If so, operation is stopped for safety purposes.) →Stand up from the seat and then use again. 	—
	<ul style="list-style-type: none"> If the water supply pressure drops significantly, for example if water is used elsewhere or if there is a water failure, the function may stop for safety. [North, Central, South America] →Disconnect the power plug and wait about 10 seconds before inserting it again. If the same symptom reappears →There may be a malfunction. Consult with the contact listed on the back cover of this manual. [Asia, Oceania, Middle East] →Disconnect the breaker on the distribution board and wait about 10 seconds before switching it ON again. If the same symptom reappears →There may be a malfunction. Consult with the contact listed on the back cover of this manual. 	—
	<ul style="list-style-type: none"> The seat sensor may have difficulty detecting some sitting postures. →Sit back on the toilet seat. 	11
	<ul style="list-style-type: none"> Are you using a toilet seat cover, a toilet lid cover or a seat for infants? →Remove any covers. When using a seat for infants or a soft highchair, remove after each use. 	—
The wand extends but water does not come out./ The cleansing water pressure is weak.	<ul style="list-style-type: none"> Has a water failure occurred?→Press the "STOP" button and wait until the water failure is over. 	—
	<ul style="list-style-type: none"> Is the water supply valve closed? 	15
	<ul style="list-style-type: none"> Is the water filter drain valve clogged with foreign matter? →Clean the filter. 	32
The cleansing water is cold.	<ul style="list-style-type: none"> Is the water pressure set to a low level? 	16
	<ul style="list-style-type: none"> Is the water temperature set to "OFF" or a low level? When the temperature of the water supply or the bathroom is low, the water temperature may be low when first sprayed. 	22 —
Stops in the middle of use.	<ul style="list-style-type: none"> Rear, soft rear, front, and wide front cleansing stop automatically after 5 minutes of continuous use, while drying stops after 10 minutes of continuous use. Does the seat switch have difficulty detecting? →Sit back on the toilet seat. If you get up slightly from the seat, or sit forward on the seat, the seating switch may temporarily stop detecting your presence. 	— 11
	<ul style="list-style-type: none"> Is the POWER LED (green) on the main display flashing? • The "ANTI-FREEZING (Dynamic mode)" is set to "ON". (Water comes out from near the wand at 5-minute intervals and the bowl unit flushes at 10-minute intervals.) (TCF9786JA only) Has the CLEAN indicator lit up in a cycle? • The wand is cleaned with "ewater+". 	50 20

Bowl unit cleansing		
Trouble	Please check	Ref. Page
The toilet does not flush even when the button is pressed.	<ul style="list-style-type: none"> Are the LEDs flickering on the Washlet control panel? • The tank is filling with water. (This takes about 60 seconds maximum.) 	—
	<ul style="list-style-type: none"> Is water available from the water supply? →Use a bucket full of water to flush. 	52
	<ul style="list-style-type: none"> Is the water supply valve fully open? 	15
The bowl unit does not flush automatically or the timing is delayed (auto bowl unit flush).	<ul style="list-style-type: none"> Is "AUTO FLUSH" set to "OFF"? →Set to "ON". Even if "AUTO FLUSH" is set to "ON", it is not available in the following instances. <ul style="list-style-type: none"> 60 seconds after the toilet is flushed →After 60 seconds have passed, flush using the remote control. When the amount of time seated on or standing in front of toilet seat is about six seconds or less After using the toilet while standing and not moving away from the front of the toilet. Solution: Step away from the toilet and wait for about three seconds. When water droplets or dirt are disrupting the body sensor. →Remove the dirt. The seat sensor may have difficulty detecting some sitting postures. →Sit back on the toilet seat. 	40 19 19 —
	<ul style="list-style-type: none"> The timing for the auto bowl unit cleaning can be changed. <ul style="list-style-type: none"> (after approx. 10 seconds →after approx. 5 or 15 seconds) 	40
	<ul style="list-style-type: none"> If the body sensor and seat switch are having detection difficulties with the "AUTO FLUSH" set to "ON", flush the toilet while you are using it. →Please sit fully on the toilet. If you get up slightly from the seat, or sit forward on the seat, the seating switch may temporarily stop detecting your presence. →Remove any dirt on the body sensor. 	40 11
	<ul style="list-style-type: none"> Is the POWER LED (green) on the main display flashing? • The "ANTI-FREEZING" is set to "ON". (Water comes out from near the wand at 5-minute intervals and the bowl unit flushes at 10-minute intervals.) (TCF9786JA only) 	50
The toilet flushes on its own.	<ul style="list-style-type: none"> Is the water supply valve fully open? 	15
	<ul style="list-style-type: none"> Is the water filter clogged? →Clean the filter. 	36
Waste material does not flush down completely.	<ul style="list-style-type: none"> Is the water supply to the toilet disrupted by other running water fixtures? →Cease using other fixtures and then flush the toilet. 	—
	<ul style="list-style-type: none"> Are the full and partial flush buttons being used correctly? • Full flush (for solid waste): up to 33 ft (10 m) of toilet paper (single) • Light flush (for liquid waste): up to 10 ft (3 m) of toilet paper (single) 	17
	<ul style="list-style-type: none"> Flushing may be difficult depending the consistency of the waste material. →Flush the toilet again. If the bowl unit is not cleansed with a flushing, remove the stains with a brush or similar instrument. 	—
	<ul style="list-style-type: none"> When the tank is filling, you cannot flush the toilet. → Once the main display "Power" LED's are lit and the tank fills up with water, flush the toilet. 	—
There is residue on the bowl unit surface	<ul style="list-style-type: none"> Oil and other hard-to-see grime may stick to the bowl unit surface. → Clean the bowl with a non-abrasive toilet detergent. 	29

Troubleshooting

Warm Air Drying		
Trouble	Please check	Ref. Page
The dryer temperature is low.	<ul style="list-style-type: none"> Is the remote control preset temperature set to a low level? 	22
Stops in the middle of use.	<ul style="list-style-type: none"> Does the seat switch have difficulty detecting? <ul style="list-style-type: none"> → Sit back on the toilet seat. If you get up slightly from the seat, or sit forward on the seat, the seating switch may temporarily stop detecting your presence. 	11

Toilet Seat and Toilet Lid (AUTO OPEN/CLOSE)		
Trouble	Please check	Ref. Page
The toilet lid does not open automatically.	<ul style="list-style-type: none"> Is "AUTO OPEN/CLOSE" set to "OFF"? → Set to "ON". Even when set to "ON", AUTO OPEN/CLOSE is not performed for about 15 seconds after the toilet seat or toilet lid is closed. <ul style="list-style-type: none"> When the toilet lid is closed by hand <ul style="list-style-type: none"> (To make the Washlet more user-friendly, a time interval is set from when the lid is closed to when it will open next.) → Move away from the toilet and wait at least 15 seconds before approaching the bowl unit again. Detection by the body sensor may be difficult when the room temperature exceeds 86°F (30°C). <ul style="list-style-type: none"> → Open and close with the remote control. 	42 — 19 —
	<ul style="list-style-type: none"> Did you set the time until the next lid opening to 30 seconds or 90 seconds? 	44
	<p>[North, Central, South America]</p> <ul style="list-style-type: none"> After the power plug is inserted, the toilet lid does not open automatically for about 10 to 60 seconds. <ul style="list-style-type: none"> → Open and close with the remote control. <p>[Asia, Oceania, Middle East]</p> <ul style="list-style-type: none"> After the distribution board breaker is switched to ON, the toilet lid does not open automatically for about 10 to 60 seconds. <ul style="list-style-type: none"> → Open and close with the remote control. 	14
	<ul style="list-style-type: none"> Is a toilet lid or seat cover installed? → Remove any covers. 	—
	<ul style="list-style-type: none"> Is "AUTO OPEN/CLOSE" set to "OFF"? → Set to "ON". When the time spent sitting on or standing in front of the toilet seat is less than 6 seconds, the toilet seat and toilet lid will close after about 5 minutes. If they do not close automatically even though "AUTO OPEN/CLOSE" is set to "ON", the body sensor may be detecting incorrectly. <ul style="list-style-type: none"> → If there is a reflective object in front, such as a mirror or glass, move the reflective object or use a curtain or other object to block it. 	42 — 11
The toilet lid opens on its own.	<ul style="list-style-type: none"> Is the sensor directly exposed to sunlight? <ul style="list-style-type: none"> → Do not directly expose the sensor to sunlight, because it may cause incorrect detection. Is there a heater within the detection range of the body sensor? <ul style="list-style-type: none"> → Do not place within the detection range of the sensor. Is a urinal or wash basin also installed in the bathroom? <ul style="list-style-type: none"> → The sensor may detect someone using the urinal, causing the toilet lid to open or close. 	11

Toilet Seat and Toilet Lid (AUTO OPEN/CLOSE)		
Trouble	Please check	Ref. Page
The toilet lid closes on its own.	<ul style="list-style-type: none"> Is "AUTO OPEN/CLOSE" set to "ON"? Is AUTO CLOSE WAITING TIME set to 25SEC? The seat sensor may have difficulty detecting some sitting postures. <ul style="list-style-type: none"> → Sit back on the toilet seat. 	42 11
The toilet lid and toilet seat open at the same time.	<ul style="list-style-type: none"> Are the settings configured to open the toilet lid and toilet seat at the same time? 	44
Stops (or closes) while opening.	<p>[North, Central, South America]</p> <ul style="list-style-type: none"> If the lid or seat hits an obstruction the first time it opens after inserting the power plug, it may stop (or close) partway during the next operation. <ul style="list-style-type: none"> → While there are no obstructions, disconnect the plug and insert it again after about 5 seconds. Then press the "SEAT OPEN/CLOSE" button on the remote control. <p>[Asia, Oceania, Middle East]</p> <ul style="list-style-type: none"> If the lid or seat hits an obstruction the first time it opens after the breaker on the distribution board is switched ON, it may stop (or close) part way through the next operation. <ul style="list-style-type: none"> → Eliminate any obstructions and switch the breaker on the distribution board to OFF. Switch it to ON again after about 5 seconds. Then press the "OPEN/CLOSE" button on the remote control. 	17
The open timing has changed.	<ul style="list-style-type: none"> Detection by the body sensor may be difficult when the room temperature exceeds 86°F (30°C), such as in the summertime. 	11

Troubleshooting

Toilet Seat and Toilet Lid		
Trouble	Please check	Ref. Page
Cannot open or close with the remote control.	<ul style="list-style-type: none"> ● If automatic opening works →Check "Is the remote control working?" ● If automatic opening does not work either <ul style="list-style-type: none"> • The toilet seat or toilet lid may not be mounted correctly. →Mount them correctly. ● Incorrect detection may occur when operating under fluorescent lights. 	55
		31
The toilet seat does not get warm.	<ul style="list-style-type: none"> ● Is the toilet seat temperature set to "OFF" or a low level? 	22
	<ul style="list-style-type: none"> ● Is the ENERGY SAVER LED (green) lit and is the SEAT LED off? <ul style="list-style-type: none"> • Timer energy-saver is operating and has turned off the toilet seat heater. →When you sit on the seat, the heater is turned on temporarily and the seat is warmed in about 15 minutes. ● Is the ENERGY SAVER LED (orange) lit? <ul style="list-style-type: none"> • If the SEAT LED is lit as well: Auto energy-saver is operating →When you sit, the toilet seat is temporarily heated. 	24
	<ul style="list-style-type: none"> ● Have you been seated for a long time? <ul style="list-style-type: none"> • After about 20 minutes of sitting, the temperature starts going down, and after about 1 hour, the heater is turned "OFF". →Move away from the toilet seat and then go back. 	—
	<ul style="list-style-type: none"> ● The seat sensor may have difficulty detecting some sitting postures. →Sit back on the toilet seat. 	11
	<ul style="list-style-type: none"> ● Is a toilet lid or seat cover installed? →Remove any covers. 	—

Energy-Saver		
Trouble	Please check	Ref. Page
The timer energy-saver feature is not working.	<ul style="list-style-type: none"> ● Did you replace the remote control batteries? <ul style="list-style-type: none"> • When the batteries are discharged, the settings may be erased. →Reconfigure the setting. 	14 26
The auto energy-saver feature is not working.	<ul style="list-style-type: none"> ● Because the function takes several days learning the usage conditions before starting energy-saver, the amount of energy saving may be low, depending on the frequency of use. →Check the type of energy-saver. 	24

Deodorizer		
Trouble	Please check	Ref. Page
The deodorizer is not working.	<ul style="list-style-type: none"> ● Even after sitting down, you do not hear operation sounds. →Sit back on the toilet seat →Set the deodorizer settings to "ON". 	46
	<ul style="list-style-type: none"> ● If you hear an operation sound when you sit on the toilet seat. →Clean the deodorizing filter. 	34
A strange odor is emitted.	<ul style="list-style-type: none"> ● Are you using an air freshener or deodorizer that you purchased separately? <ul style="list-style-type: none"> • Doing so may reduce the effectiveness of the Washlet deodorizer or cause strange odors. →Remove the air freshener or deodorizer. 	—
The deodorizer is not working.	<ul style="list-style-type: none"> ● Is "DEODORIZER" set to "OFF"? →Set to "ON". 	46

Sanitary		
Trouble	Please check	Ref. Page
The soft light, bowl unit LED and CLEAN indicator do not light up.	<ul style="list-style-type: none"> ● Is the setting "OFF"? →Set to "ON". ● If the CLEAN indicator LED is off, it is time to replace the component that generate a "ewater+". (Replacement will be charged) Consult with the installer, the seller, or the contact referred on the back cover of this manual. (Frequency of use is assumed that a family of four, 2 male and 2 female) 	48 —
The pre-mist sprays out spontaneously.	<ul style="list-style-type: none"> ● When body sensor A detects someone, the pre-mist is sprayed. ● When the bowl has not been cleaned in 8 hours, the mist is sprayed inside the bowl unit automatically. 	—

Others		
Trouble	Please check	Ref. Page
Water is leaking from the plumbing connections.	<ul style="list-style-type: none"> ● If any nuts in a connection are loose, firmly tighten them with a tool such as a monkey wrench. →If the water leak does not stop, close the water supply valve and seek repair. 	—
The top unit is unstable.	<ul style="list-style-type: none"> ● There is clearance between the toilet seat cushion and the bowl unit for activating the seat sensor. When you sit on the toilet seat, the toilet seat subsides slightly to activate the seat sensor. 	11
Water splashes up when using the toilet	<ul style="list-style-type: none"> ● The water in the bowl unit that is used to mask the smell of excrement is the cause of the splashing. →Adding a layer of toilet paper on the surface of the water can slightly dampen splashing. 	—
When cleansing, you hear a squishing sound underneath the floor.	<ul style="list-style-type: none"> ● Flush the toilet and check for sounds coming from the discharge pipe. Use a device that maintains the necessary toilet water level. 	—
When you flush, you hear a gurgling sound.	<ul style="list-style-type: none"> ● When the toilet is flushed together with waste material, the sound is a result of air, waste material and water being pulled through the system. 	—

Specifications

Limited Warranty

SN982M
(MS982CUMG)

Item			SN982M	TCF9786JA	
Rated power supply			AC120 V, 60Hz	AC220 V, 50/60Hz	
Rated power consumption			836 W	831W	
Maximum power consumption			1413 W <When the water supply temperature is 32°F(0°C)>	1276 W <When the water supply temperature is 32°F(0°C)>	
Type			Instantaneous		
Power cord length			3.9ft (1.2 m)		
Bowl unit features	Flush volume		Floor drain : Full 1.0 gal (3.8L), Light 0.87gal (3L)	Floor drain : Full 1.0 gal (3.8L), Light 0.87gal (3L) Wall drain : Full 1.3 gal (4.8L), Light 0.9gal (3.4L)	
	Water supply system		Direct supply/Pressurized supply		
	Flush type		Cyclone flushing <Siphon type>		
	Bowl style		Elongated		
Anti-freezing (TCF9786JA only)	Dynamic type	Flush volume (dynamic)	8.56 gal/h (32.4 L/h)		
Washlet	Spray volume	Rear cleansing	About 0.07 to 0.11 gal/min. (About 0.27 to 0.43 L/min.) <at 29 PSI (0.2 MPa) water pressure>		
		Soft rear cleansing	About 0.08 to 0.11 gal/min. (About 0.32 to 0.43 L/min.) <at 29 PSI (0.2 MPa) water pressure>		
		Front cleansing	About 0.08 to 0.11 gal/min. (About 0.29 to 0.43 L/min.) <at 29 PSI (0.2 MPa) water pressure>		
		Wide front cleansing	About 0.09 to 0.11 gal/min. (About 0.35 to 0.43 L/min.) <at 29 PSI (0.2 MPa) water pressure>		
	Water temperature		Temperature adjustable range: OFF, About 86 to 104°F (About 30 to 40°C)		
	Heater capacity		1200W		
	Safety device		Temperature fuse		
	Backflow prevention device		Vacuum breaker, check valve		
	Dryer	Warm air temperature *		Temperature adjustment range: About 95 to 140°F (About 35 to 60°C)	Temperature adjustment range: About 95 to 131°F (About 35 to 55°C)
		Airflow volume		10.2 ft ³ /min (0.29 m ³ /min)	
Heater capacity		350W			
Safety device		Temperature fuse			
Heated seat	Surface temperature		Temperature adjustable range: OFF, About 82 to 97°F (About 28 to 36°C) <In auto energy-saver: About 79°F (About 26°C)>		
	Heater capacity		49.5W	45.4W	
	Safety device		Temperature fuse		
Deodorizer	Method		O ₂ deodorizing		
	Airflow volume		About 5.7 ft ³ /min (About 0.16 m ³ /min)		
Power consumption		About 5.3 W			
Water supply pressure			Minimum required water pressure: 7 PSI (0.05MPa) <Dynamic> Maximum water pressure: 110 PSI (0.75MPa) <Static>		
Supply water temperature			32 to 95°F (0 to 35°C)		
Working ambient temperature			32 to 104°F (0 to 40°C)		
Dimensions			W1.3 ft x D2.3 ft x H1.8 ft (W389 mm x D705 mm x H547 mm)		
Weight			About 85.5 lb <Top unit 13.9 lb, Bowl unit 71.7 lb> (About 38.8 kg <Top unit 6.3 kg, Bowl unit 32.5 kg>)		

* Temperature around the warm air outlet measured by TOTO.

Three Year Limited Warranty

- TOTO warrants its Neorest brand product ("Product") to be free from defects in materials and workmanship during normal use when properly installed and serviced, for a period of three (3) years from date of purchase. This limited warranty is extended only to the ORIGINAL PURCHASER of the Product and is not transferable to any third party, including but not limited to any subsequent purchaser or owner of the Product. This warranty applies only to TOTO Product is purchased and installed in North, Central and South America.
- TOTO's obligations under this warranty are limited to repair, replacement or other appropriate adjustment, at TOTO's option, of the Product or parts found to be defective in normal use, provided that such Product was properly installed, used and serviced in accordance with instructions. TOTO reserves the right to make such inspections as may be necessary in order to determine the cause of the defect. TOTO will not charge for labor or parts in connection with warranty repairs or replacements. TOTO is not responsible for the cost of removal, return and/or reinstallation of the Product.
- This warranty does not apply to the following items:
 - Damage or loss sustained in a natural calamity such as fire, earthquake, flood, thunder, electrical storm, etc.
 - Damage or loss resulting from any accident, unreasonable use, misuse, abuse, negligence, or improper care, cleaning, or maintenance of the Product.
 - Damage or loss resulting from sediments or foreign matter contained in a water system.
 - Damage or loss resulting from improper installation or from installation of the Product in a harsh and/or hazardous environment, or improper removal, repair or modification of the Product. This includes locations where the water pressure is above local codes or standards. (NOTE : Product model codes allow a maximum of 80 PSI. Check local codes or standards for requirements).
 - Damage or loss resulting from electrical surges or lightning strikes or other acts which are not the fault of TOTO or which the Product is not specified to tolerate, including failure to use the factory equipped cord and plug or use of a loose or faulty electrical outlet or use of a current or socket other than a 120V, 60Hz electrical current from a GFI (ground, fused) socket.
 - Damage or loss resulting from normal and customary wear and tear, such as gloss reduction, scratching or fading over time due to use, cleaning practices or water or atmospheric conditions, including but not limited to, the use of bleach, alkali, acid cleaners, dry (powder) cleaners or any other abrasive cleaners or the use of metal or nylon scrubbers.
- If the Danger Label which has been placed over the seams on the back of the Product's top unit is broken or otherwise not intact, this limited warranty is void.
- In order for this limited warranty to be valid, proof of purchase is required. TOTO encourages warranty registration upon purchase to create a record of Product ownership at <http://www.totousa.com>. Product registration is completely voluntary and failure to register will not diminish your limited warranty rights.
- If the Product is used commercially or is installed outside of North, Central or South America, TOTO warrants the Product to be free from defects in materials and workmanship during normal use for one (1) year from the date of installation of the Product, and all other terms of this warranty shall be applicable except the duration of the warranty.
- THIS WARRANTY GIVES YOU SPECIFIC LEGAL RIGHTS. YOU MAY HAVE OTHER RIGHTS WHICH VARY FROM STATE TO STATE, PROVINCE TO PROVINCE OR COUNTRY TO COUNTRY.
- To obtain warranty repair service under this warranty, you must take the Product or deliver it prepaid to a TOTO service facility together with proof of purchase (original sales receipt) and a letter stating the problem, or contact a TOTO distributor or products service contractor, or write directly to TOTO U.S.A., INC., 1155 Southern Road, Morrow, GA 30260 (888) 295 8134 or (678) 466-1300, if outside the U.S.A. If, because of the size of the Product or nature of the defect, the Product cannot be returned to TOTO, receipt by TOTO of written notice of the defect together with proof of purchase (original sales receipt) shall constitute delivery. In such case, TOTO may choose to repair the Product at the purchaser's location or pay to transport the Product to a service facility.

WARNING! TOTO shall not be responsible or liable for any failure of, or damage to, this Product caused by either chloramines in the treatment of public water supply or cleaners containing chlorine (calcium hypochlorite). NOTE: The use of a high concentrate chlorine or chlorine related product's can seriously damage the fittings. This damage can cause leakage and serious property damage.

THIS WRITTEN WARRANTY IS THE ONLY WARRANTY MADE BY TOTO. REPAIR, REPLACEMENT OR OTHER APPROPRIATE ADJUSTMENT AS PROVIDED UNDER THIS WARRANTY SHALL BE THE EXCLUSIVE REMEDY AVAILABLE TO THE ORIGINAL PURCHASER. TOTO SHALL NOT BE RESPONSIBLE FOR LOSS OF THE PRODUCT OR FOR OTHER INCIDENTAL, SPECIAL OR CONSEQUENTIAL DAMAGES OR EXPENSES INCURRED BY THE ORIGINAL PURCHASER, OR FOR LABOR OR OTHER COSTS DUE TO INSTALLATION OR REMOVAL, OR COSTS OF REPAIRS BY OTHERS, OR FOR ANY OTHER EXPENSE NOT SPECIFICALLY STATED ABOVE. IN NO EVENT WILL TOTO'S RESPONSIBILITY EXCEED THE PURCHASE PRICE OF THE PRODUCT. EXCEPT TO THE EXTENT PROHIBITED BY APPLICABLE LAW, ANY IMPLIED WARRANTIES, INCLUDING THAT OF MERCHANTABILITY OR FITNESS FOR USE OR FOR A PARTICULAR PURPOSE, ARE EXPRESSLY DISCLAIMED. SOME STATES DO NOT ALLOW LIMITATIONS ON HOW LONG AN IMPLIED WARRANTY LASTS, OR THE EXCLUSION OR LIMITATION OF INCIDENTAL OR CONSEQUENTIAL DAMAGES, SO THE ABOVE LIMITATION AND EXCLUSION MAY NOT APPLY TO YOU.

Warranty

TCF9786JA
<Bowl unit: CS985type>

MEMO

LIMITED ONE YEAR WARRANTY

1. TOTO warrants its products to be free from manufacturing defects under normal use and service for a period of one (1) year from the date of purchase. This warranty is extended only to the ORIGINAL PURCHASER.
2. TOTO's obligations under this warranty are limited to repair or replacement, at TOTO's option, of products or parts found to be defective, provided that such products were properly installed and used in accordance with this OWNER'S MANUAL. TOTO reserves the right to make such inspections as may be necessary to determine the cause of the defect. TOTO will not charge for labor or parts in connection with warranty repairs or replacements. **TOTO is not responsible for the cost of removal, return and/or reinstallation of products.**
3. This warranty does not apply to the following items:
 - a) Damage or loss sustained in a natural calamity such as fire, earthquake, flood, thunder, electrical storm, etc.
 - b) Damage or loss resulting from any unreasonable use, misuse, abuse, negligence, or improper maintenance of the product.
 - c) Damage or loss resulting from removal, improper repair, or modification of the product.
 - d) Damage or loss resulting from sediments or foreign matter contained in a water system.
 - e) Damage or loss resulting from improper installation or from installation of a unit in a harsh and/or hazardous environment.
 - f) Damage or loss resulting from electrical surges or lightning strikes or other acts which are not the fault of TOTO or which the Washlet is not specified to tolerate.
 - g) Damage or loss resulting from normal and customary wear and tear, such as gloss reduction, scratching or fading over time due to use, cleaning practices or water or atmospheric conditions.
4. This warranty gives you specific legal rights. You may have other rights which vary from country to country.
5. To obtain warranty repair service under this warranty, you must take the product or deliver it prepaid to a TOTO service facility, together with a letter stating the problem, or contact a TOTO distributor or product service contractor, or directly to TOTO sales office. If, because of the size of the product or nature of the defect, the product can not be returned to TOTO, receipt by TOTO of written notice of the defect shall constitute delivery. In such case, TOTO may choose to repair the product at the purchaser's location or pay to transport the product to a service facility.

WARNING! TOTO shall not be responsible or liable for any failure of, or damage to, this Product caused by either chloramines in the treatment of public water supply or cleaners containing chlorine (calcium hypochlorite).

NOTE: The use of a high concentrate chlorine or chlorine related product's can seriously damage the fittings. This damage can cause leakage and serious property damage.

THIS WRITTEN WARRANTY IS THE ONLY WARRANTY MADE BY TOTO. REPAIR OR REPLACEMENT AS PROVIDED UNDER THIS WARRANTY SHALL BE THE EXCLUSIVE REMEDY AVAILABLE TO THE PURCHASER. TOTO SHALL NOT BE RESPONSIBLE FOR LOSS OF USE OF THE PRODUCT OR FOR OTHER INCIDENTAL, SPECIAL, OR CONSEQUENTIAL DAMAGE OR EXPENSES INCURRED BY PURCHASER, OR FOR LABOR OR OTHER COSTS DUE TO INSTALLATION OR REMOVAL, OR COSTS OF REPAIRS BY OTHERS, OR FOR ANY OTHER EXPENSE NOT SPECIFICALLY STATED ABOVE. EXCEPT TO THE EXTENT PROHIBITED BY APPLICABLE LAW, ANY IMPLIED WARRANTIES, INCLUDING THAT OF MERCHANTABILITY OR FITNESS FOR USE, ARE EXPRESSLY LIMITED TO THE DURATION OF THIS WARRANTY. SOME STATES DO NOT ALLOW LIMITATIONS ON HOW LONG AN IMPLIED WARRANTY LASTS, OR THE EXCLUSION OR LIMITATION OF INCIDENTAL OR CONSEQUENTIAL DAMAGE, SO THE ABOVE LIMITATION AND EXCLUSION MAY NOT APPLY TO YOU.

MEMO

MEMO