

# TOTO

# WASHLET

Instruction Manual



## washlet

SW3056AT40, SW3056  
SW3046AT40, SW3046



SW3054AT40, SW3054  
SW3044AT40, SW3044



- Thank you for your recent purchase of this product.  
Please read the enclosed information to ensure the safe use of your product.
- Be sure to read this Instruction Manual before using your product and keep it in a safe place for future reference.

# The available functions vary according to the model.

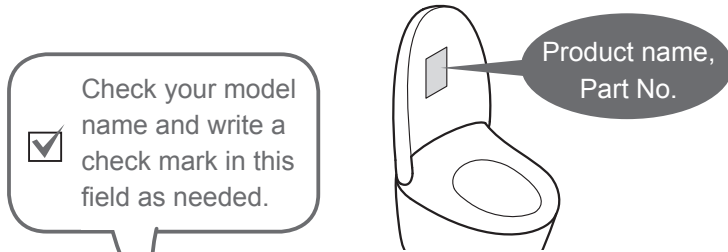

Check your model name and write a check mark in this field as needed.

Functions		Product name (Model)	WASHLET				Ref. Page
		Part No.	SW3056AT40	SW3056	SW3046AT40	SW3046	
		Your Model	SW3054AT40	SW3054	SW3044AT40	SW3044	
Basic Functions	Cleansing	Rear cleansing					20, 21
		Rear soft cleansing	●	●	●	●	
		Front cleansing					
		Wide front cleansing					
	Changing the cleansing method	Wand position adjustment					
		Water pressure adjustment	●	●	●	●	
		Oscillating cleansing					
		Pulsating cleansing					
	Drying	Warm air drying	●	●	●	●	
Changing the temperature	Temperature adjustment	●	●	●	●	28, 29	
Sanitary Functions	Removing odors	Deodorizer	●	●	●	●	24, 25
	"ewater+" cleaning	Auto wand CLEAN	●	●	●	●	
		Auto bowl CLEAN					
Convenience Functions	Flushing	Remote control flushing	●*1	—	●*1*2	—	20
		Auto flushing					26, 27
	Opening and closing	Opening and closing the toilet seat with remote control	●	●	—	—	20
		Auto open / close					26, 27
	Lighting up	Soft light	●	●	—	—	
	Heating the toilet seat	Heated seat	●	●	●	●	—
	Save energy by lowering the toilet seat temperature	Auto energy saver					
		Auto energy saver+	●	●	●	●	30, 31
Timer energy saver							
Maintenance		Main Unit One-touch removal					38, 39
		Removable toilet lid	●	●	●	●	40
		Wand cleaning					37

\*1 Available only when "FLUSH" button is located on the top side of the remote control.  
 \*2 Auto flushing will not be activated when the user uses the toilet in standing position.

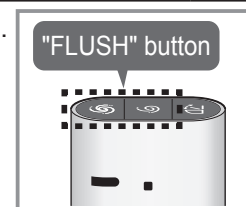

# Keep It Clean

## Sanitary Toilet



The self-cleaning functions operate automatically.  
(See pages 24 and 25 for details.)

	As you approach	As you sit	As you stand up
Removing odors inside the bowl unit		Deodorizer	Auto power deodorizer
Cleans the bowl unit with "ewater+"	Auto bowl CLEAN		Auto bowl CLEAN
Cleans the wand with "ewater+"			Auto bowl CLEAN



## Table of Contents

Safety Precautions..... 4	Introduction
Operational Precautions ..... 11	
Parts Names..... 14	
Preparation ..... 18	
Basic Operations..... 20	Operation
Automatic Functions (Cleaning Features)..... 24	
Deodorizer, Auto wand CLEAN, Auto bowl CLEAN, Bowl light, CLEAN Indicator	
Automatic Functions (Convenience Features) ..... 26	
Auto flushing, Auto open/close, Soft light	
Temperature Adjustment (Warm Water, Toilet Seat, Drying)··· 28	
Energy Saver Features ..... 30	
Maintenance ..... 34	Maintenance
● Power plug..... 34	
● Main Unit ..... 35	
● Deodorizing Filter ..... 36	
● Wand ..... 37	
Wand cleaning	
● Gap between the Main Unit and Bowl Unit ..... 38	
● Gap between the Main Unit and the Toilet Lid ..... 40	
● Water Filter Drain Valve..... 41	
Changing Settings ..... 42	Reference
What to Do?..... 62	
● If the water does not flow due to a water service interruption ..... 62	
● If you cannot operate with the remote control ..... 62	
● Freeze Damage Prevention..... 63	
● Long Periods of Disuse ..... 64	
● Removal of Operation Guide ..... 65	
Troubleshooting..... 66	
Specifications ..... 73	
Warranty..... 74	



# Safety Precautions

## IMPORTANT SAFEGUARDS READ ALL INSTRUCTIONS BEFORE USING



### Symbols and Meanings

	<b>WARNING</b>	May result in death or serious injury.
	<b>CAUTION</b>	May result in injury or property damage.

The following symbols are used to indicate important safety instructions for the use of the product.

Symbol	Meaning
	This symbol indicates a prohibited use of the product.
	This symbol is used to indicate a required step in the use of this product.

- This product is classified as Class 1 Equipment and must be grounded.
- Install this equipment where the electrical outlet is accessible.
- This appliance is not intended for use by persons (including children) with reduced physical, sensory or mental capabilities, or lack of experience and knowledge, unless they have been given supervision or instruction concerning use of the appliance by a person responsible for their safety. Children should be supervised to ensure that they do not play with the appliance.
- Use the new hose set included with this equipment. Do not reuse an old hose set.

 <b>WARNING</b>	
	<p><b>Do not plug or unplug the power plug with wet hands.</b></p> <ul style="list-style-type: none"> <li>• Doing so may cause electrical shock.</li> </ul>
	<p><b>Do not get any water or cleaning solution on the main unit or power plug.</b></p> <ul style="list-style-type: none"> <li>• Doing so may cause fire, electrical shock, heat or short circuit.</li> <li>• Doing so may cause the product to crack resulting in injury or water damage.</li> </ul>
	<p><b>Never disassemble, repair or alter.</b></p> <ul style="list-style-type: none"> <li>• Doing so may cause fire, electrical shock, overheating, short circuit or breakdown.</li> </ul>
	<p><b>Do not install the product on moving vehicles such as wheeled vehicles or boats.</b></p> <ul style="list-style-type: none"> <li>• Doing so may cause fire, electric shock, short circuit or malfunction.</li> <li>• The toilet seat, toilet lid, main unit, or other parts may come loose and fall off, resulting in injury.</li> </ul>



## WARNING

### Do not use the product if a malfunction occurs.

- In case of breakdown or other problem, be sure to cut off power by means such as unplugging the power plug.  
Close the water shutoff valve to stop water supply.  
Possible malfunctions:
  - Water is leaking from a pipe or the main unit.
  - The product is cracked or broken.
  - The product makes a strange noise or emits a strange odor.
  - The product emits smoke.
  - The product is abnormally hot.
  - The toilet seat cushion is out of place.
- Continued use after malfunction could cause a fire, electric shock, heat, short circuit, injury or water damage.

### Do not use other water than allowed by the laws and ordinances of the region of use.

### Only use potable water. Do not use seawater or recycled water.

- Doing so may cause irritation to the skin and malfunction.

### Do not touch the power plug during thunderstorms.

- Doing so may cause electrical shock.



### Do not allow the water supply hose to touch the power plug or outlet.

- Doing so may cause condensation resulting in a fire, electrical shock, heat or a short.

### Do not do anything that may damage the power cord, power plug.

Do not strike, yank, twist, excessively bend, damage, alter, or heat the power cords.

Also, do not place anything heavy on, bind or pinch the power cords.

- Using a damaged power cord may result in a fire, electrical shock, heat or short.

### Do not use a loose or faulty electrical outlet.

- Doing so may cause fire or short circuit.

### Do not use any outlet or wiring equipment beyond its specified rating.

- Plugging too many plugs into the same outlet, for example using outlet splitters, can cause fire due to heat.

### Do not use any power supply other than the one specified.

#### AC 120 V, 60Hz

- Doing so may cause fire or excessive heat.

### Do not stick a finger or anything else into the warm air outlet.

Do not place anything on the warm air outlet or drape clothes over it.

- Doing so may cause burns, electrical shock or malfunction.

### Keep cigarettes and other open flames away from the product.

- Failure to do so may cause fire.

# Safety Precautions (Continued)

## WARNING

### **Refrain from sitting on the seat for long periods.**

- It may cause low-temperature burns.

To prevent the following persons from getting a moderate temperature burn during use, other person should turn off the toilet seat heater and set the dryer temperature to "Low".

- Young children, the aged and other users unable to set the temperature appropriately themselves.
- The ill, physically disabled and others who do not have freedom of movement.
- Those using any medicines that cause drowsiness (sleeping or cold medicine), those who have been drinking heavily, anyone severely fatigued and anyone else liable to fall asleep.

**This is an electrical product. Do not install it anywhere water is likely to get on the product or anywhere with humidity high enough that water is likely to form on the surface of this product. When using the product in a bathroom, install a fan or ventilation port and ensure good air flow through the bathroom.**

- Failure to do so may cause fire or electrical shock.

### **Always connect the product to the cold water supply.**

- Connecting to hot water supply may result in burns and equipment damage.

### **Make sure that a properly grounded (3 prong) outlet has been installed.**

- Failure to install a grounded outlet could cause electrical shock in the event of a malfunction or short circuit.



### **Insert the power plug securely into the outlet.**

- Failure to do so may cause fire, heat or short circuit.

### **To unplug, hold the power plug, not the power cord.**

**Do not unplug by pulling the power cord.**

- Pulling on the power cord may cause damage and result in fire or heat.

**If the electric cord is damaged, avoid danger by having the manufacturer's repair department or equivalent specialist replace it.**

### **Always unplug the power plug from the outlet before maintenance or inspection.**

- Failure to do so may cause electrical shock or malfunction.

### **Periodically remove dust and dirt from the power plug and make sure it is securely plugged into the wall outlet.**

- Failure to do so may cause fire, heat or short circuit.

Pull the power plug out from the outlet and wipe clean with a dry cloth.

### **Always unplug the plug from the outlet before removing the main unit.**

- Failure to do so may cause a fire or electrical shock.

## **WARNING**



**When leaking battery fluid adheres to your body or clothes, wash it away with clean water.**

- The fluid may damage your eyes or skin.

**Preliminary studies in females suggest that overuse of continuous spraying can increase the possibility of vaginal mucosa drying and potential reduction in desirable microbial organisms.**

**Although these studies have not been validated, please consult your healthcare provider for concerns regarding whether these circumstances may apply to you.**

**More importantly, if you are an individual suffering from any immune deficiency as a result of disease, chemotherapy, or other medical condition compromising the immune system you should consult your healthcare provider before use of this product.**

## **CAUTION**



**Do not use the product if the main unit is unstable.**

- Doing so may cause the main unit to come loose and fall, resulting in injury.

**If the product is damaged, do not touch the damaged section.**

- Doing so may cause electrical shock or injury. Replace it immediately.

**Do not apply strong force, mechanical shock, step on or stand on the toilet seat, toilet lid or main unit. Also do not place any heavy object on the toilet seat, toilet lid or main unit.**

- Doing so may cause cracking or cause the main unit to come loose and fall, resulting in injury.
- Doing so may damage the product and cause injury or water damage.

**Do not lift up this product by the toilet seat or lid.**

**Do not raise the toilet seat or lid while objects are resting on top of the unit.**

- Doing so may cause the main unit to come loose and fall, resulting in injury.

**When maintaining the plastic parts (main unit etc.) or the water supply hose, use a neutral kitchen detergent diluted with water. Do not use any of the following.**

**Toilet cleaner, household cleaner, benzene, paint thinner, powdered cleanser or nylon scrubbing brush.**

- These items may damage or crack the plastic and cause injury or malfunction.
- These items could damage the water supply hose and cause a water leak.

**To prevent a sudden water leak, do not remove the water filter drain valve when the shutoff valve is open.**

- Doing so will cause water to spurt out.

(Refer to Page 41 for instructions on cleaning the water filter drain valve.)

# Safety Precautions (Continued)

## CAUTION

	<p><b>Do not fold or crush the water supply hose; do not damage by cutting with a sharp object.</b></p> <ul style="list-style-type: none"> <li>• Doing so may cause water leaks.</li> </ul> <p><b>Do not install the base plate, which is not attached.</b></p> <ul style="list-style-type: none"> <li>• Doing so may cause damage.</li> </ul>
---	--

	<p><b>If a water leak should occur, always close the shutoff valve.</b></p> <p><b>When the ambient temperature is likely to drop to 0°C or lower, prevent damage to the pipes and hoses due to freezing.</b></p> <ul style="list-style-type: none"> <li>• Frozen water pipes could cause the main unit and the pipes to break, resulting in a water leak.</li> <li>• Regulate the room temperature to prevent the pipes and hoses from freezing during cold months.</li> <li>• Drain the water.</li> </ul> <p><b>When not using the product over an extended period of time, drain the water out of the top unit and the water supply hose after closing the water shutoff valve, and pull the power plug from the outlet.</b></p> <ul style="list-style-type: none"> <li>• When using the product again, allow the product to refill with water first. Otherwise, the water in the tank might become contaminated and cause skin inflammation or other problems. (Refer to Page 64 for instructions on replenishing the water.)</li> <li>• Leaving the power on may cause fire or heat.</li> </ul> <p><b>When installing the water filter drain valve, make sure that it is securely tightened in its proper position.</b></p> <ul style="list-style-type: none"> <li>• Failure to securely tighten it may cause a water leak.</li> </ul> <p><b>If the bowl unit is clogged, unplug the power plug and remove the clog.*1</b></p> <ul style="list-style-type: none"> <li>• If the auto flush were allowed to function, it would make the wastewater in the bowl unit overflow and may result in water damage.</li> <li>• Use commercially available tools that are made for unclogging the bowl unit to remove the clogging.</li> </ul> <p><b>Push the main unit securely on to the base plate.</b></p> <ul style="list-style-type: none"> <li>• After pushing the main unit until a click sound is heard, pull it slightly toward you to make sure that the product does not detach.</li> <li>• Failure to do so could cause the main unit to come loose and fall resulting in injury.</li> </ul> <p><b>Make sure of the plus and minus signs on the batteries before inserting them. Remove depleted batteries immediately.</b></p> <p><b>When replacing the batteries:</b></p> <ul style="list-style-type: none"> <li>Replace both batteries with new ones.</li> <li>Use the same brand for both new batteries (any brand available).</li> <li>• Failure to do so may cause the batteries to leak fluid, generate heat, rupture, or ignite.</li> </ul> <p><b>When the product is supposed not to be used for long time, remove the batteries from the remote control.</b></p> <ul style="list-style-type: none"> <li>• Failure to do so may cause the batteries to leak fluid.</li> </ul>
---	---

\*1 Available only when "FLUSH" button is located on the top side of the remote control.



** DANGER** To reduce the risk of electrocution:

1. Do not use while bathing.
2. Do not place or store the product where it can fall or be pulled into a tub or sink.
3. Do not place in or drop into water or other liquid.
4. Do not reach for the product when it has fallen into water. Unplug immediately.

** WARNING** To reduce the risk of burns, electrocution, fire or injury to persons:

1. Close supervision is necessary when this product is used by, on, or near children or invalids.
2. Use this product only for its intended use as described in this manual. Do not use attachments not recommended by the manufacturer.
3. Never operate this product if it has a damaged cord or plug, is not working properly, has been dropped or damaged, or has been dropped in water. Return the product to a service center for examination and repair.
4. Keep the cord away from heated surfaces.
5. Never block the air openings on the product or place it on a soft surface, such as a bed or couch, where the air openings may be blocked. Keep the air openings free of lint, hair, and other similar items.
6. Never use while sleepy or drowsy.
7. Never drop or insert any object into any opening or hose.
8. Do not use outdoors. Do not operate where aerosol (spray) products are being used or where oxygen is being administered.
9. Connect this product to a properly grounded outlet only.  
See "Grounding Instructions" in Page 10.
10. The tank should be filled with water only.

- Servicing should be performed by an authorized service representative.
- This product is for household use.

# Safety Precautions (Continued)

## Grounding Instructions

This product should be grounded. In the event of an electrical short circuit, grounding reduces the risk of electric shock by providing an escape wire for the electrical current.

The plug must be plugged into an outlet that is properly installed and grounded.

 **DANGER** - Improper use of the grounding plug can result in a risk of electric shock.

If repair or replacement of the cord or plug is necessary, do not connect the grounding wire to either flat-head terminal.

Check with a qualified electrician or serviceman if the grounding wire instructions are not completely understood, or if in doubt as to whether the product is properly grounded.

This product is factory equipped with a specific electric cord and plug to permit connection to a proper electric circuit. Make sure that the product is connected to an outlet having the same configuration as the plug.

No adapter should be used with this product. Do not modify the plug provided - if it will not fit in the outlet, have the proper outlet installed by a qualified electrician.

If the product must be reconnected for use on a different type of electric circuit, the reconnection should be made by qualified service personnel.

If it is necessary to use an extension cord, use only a three wire extension cord that has a three blade grounding plug, and a three-slot receptacle outlet that will accept the plug on the product.

Replace or repair a damaged cord.

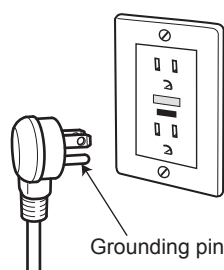

**SAVE THESE INSTRUCTIONS**

# Operational Precautions

## ■ For prevention of malfunctions

### < About the seat switch >

- When you sit on the toilet seat, the seat switch turns ON, enabling you to use various features. (A click sound is heard when the seat switch is ACTIVATED.)

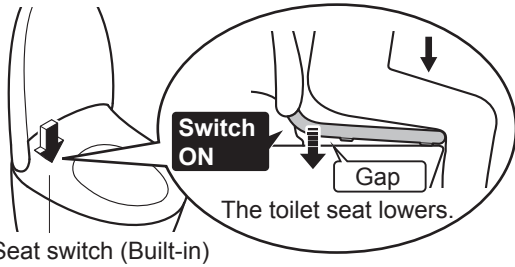

- Sit back on the toilet seat.
  - The seat switch will not turn on unless you sit on the seat properly.



### Note

- When a child uses the product, the seat switch may not be ACTIVATED by their light body weight.
- Since the toilet seat is designed to move up and down, a clearance is provided between the toilet seat cushion and the bowl unit.

## ■ For prevention of damage

- Wipe plastic areas such as the main unit and remote control with a soft cloth tightly wrung out with water.
- Do not lean against the toilet lid.



## ■ For prevention of malfunctions and failures

- Do not block the remote control transmitter or receiver. (May cause main unit to malfunction)
- A toilet seat cover or a toilet lid cover cannot be used.



- Disconnect the power plug if there is a risk of lightning.
- Do not urinate on the main unit, toilet seat or wand. (Doing so may cause a failure or discoloration.)
- Do not apply strong forces to the control panel of the remote control.
- When using a toilet cleaner to clean the toilet, rinse it off within 3 minutes and leave the toilet seat and toilet lid open.
  - Wipe off any cleaner that remains on the bowl unit. (If vapor from a toilet cleaner enters the main unit, it may cause a malfunction.)
- Do not use the product with the toilet lid removed.
- Do not expose to direct sunlight. (Doing so may cause changes in color, irregular heated seat temperature, remote control malfunction or the product malfunction due to the change in temperature.)
- Use radios, etc. away from the product. (The product could cause interference with the radio signal.)
- If you use a booster seat for infants or a soft highchair, remove it after use. (Keeping it installed may prevent some of the functions from being used.)
- Do not apply force to the remote control. (May cause malfunction.) To prevent the remote control from being dropped, set it in the hanger when you are not using it. Be careful not to expose it to water.
- Do not place anything on the toilet seat and lid, and do not press them with hands. (Failure to do so may turn on the seat switch, causing the floor to get wet if buttons on the remote control are touched and warm water comes out from the wand.)

# Operational Precautions (Continued)

## ■ Body Sensor Compliance

### ● FEDERAL COMMUNICATIONS COMMISSION (FCC) INTERFERENCE STATEMENT

This equipment has been tested and found to comply with the limits for a Class B digital device, pursuant to part 15 of the FCC Rules. These limits are designed to provide reasonable protection against harmful interference in a residential installation. This equipment generates, uses and can radiate radio frequency energy and, if not installed and used in accordance with the instructions, may cause harmful interference to radio communications.

However, there is no guarantee that interference will not occur in a particular installation.

If this equipment does cause harmful interference to radio or television reception, which can be determined by turning the equipment off and on, the user is encouraged to try to correct the interference by one or more of the following measures:

- Reorient or relocate the receiving antenna.
- Increase the separation between the equipment and receiver.
- Connect the equipment into an outlet on a circuit different from that to which the receiver is connected.
- Consult the dealer or an experienced radio/TV technician for help.

#### **CAUTION:**

Any changes or modifications not expressly approved by the grantee of this device could void the user's authority to operate the equipment.

This device complies with part 15 of the FCC Rules.

Operation is subject to the following two conditions:

- (1) this device may not cause harmful interference, and
- (2) this device must accept any interference received, including interference that may cause undesired operation.

#### **RF exposure warning**

This equipment complies with FCC RF exposure limits set forth for an uncontrolled environment.

This equipment must not be co-located or operating in conjunction with any other antenna or transmitter.

### ● Canada, Industry Canada (IC) Notices

This device complies with Industry Canada's licence-exempt RSSs.

Operation is subject to the following two conditions:

- (1) This device may not cause interference; and
- (2) This device must accept any interference, including interference that may cause undesired operation of the device.

#### **Radio Frequency (RF) Exposure Information**

The radiated output power of the Wireless Device is below the Industry Canada (IC) radio frequency exposure limits. The Wireless Device should be used in such a manner such that the potential for human contact during normal operation is minimized.

This device has also been evaluated and shown compliant with the IC RF Exposure limits under portable exposure conditions.

(antennas are less than 8 inch (20 cm) of a person's body).



# Parts Names

SW3056AT40, SW3056  
 SW3046AT40, SW3046

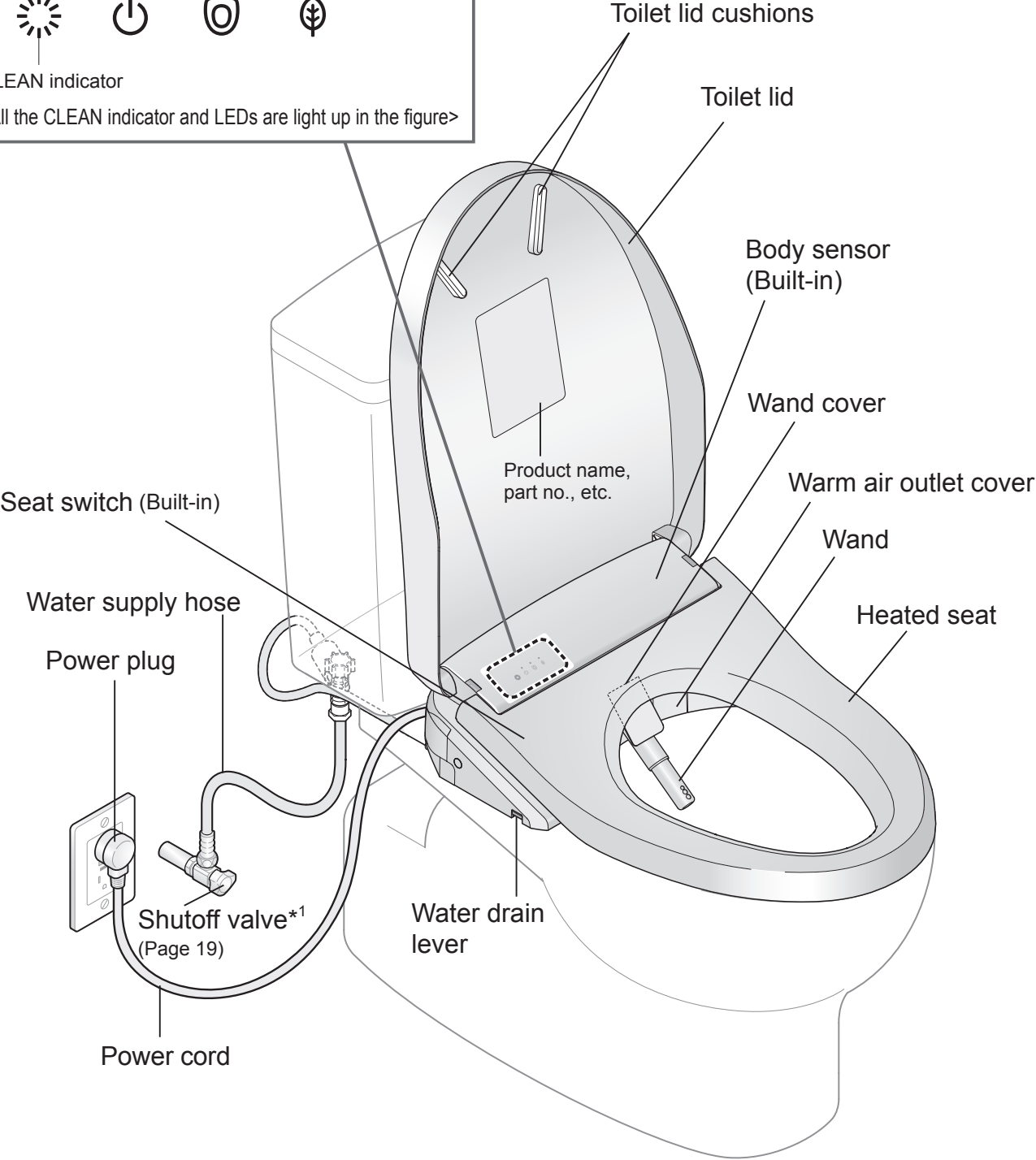
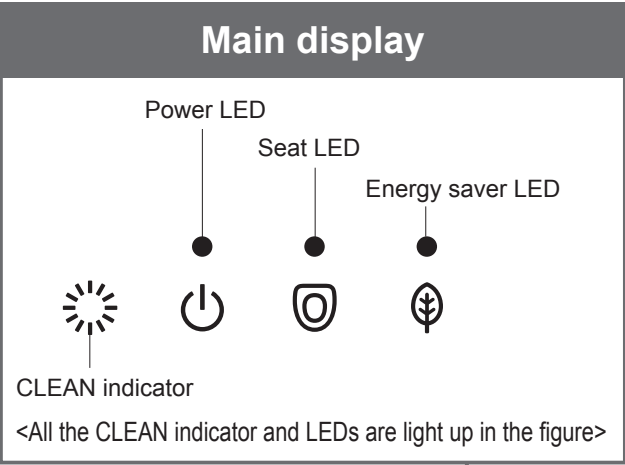

Descriptions in this manual are based on the illustrations of SW3056

Toilet seat cushions

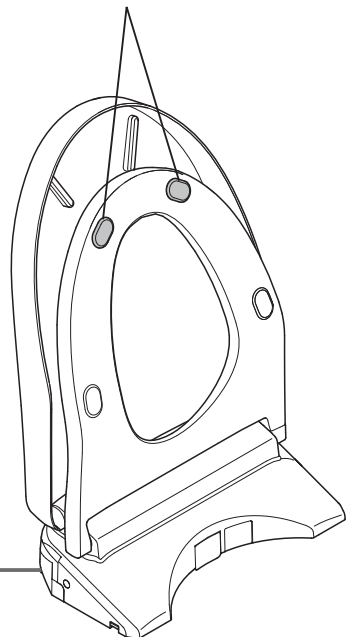

Right rear of main unit

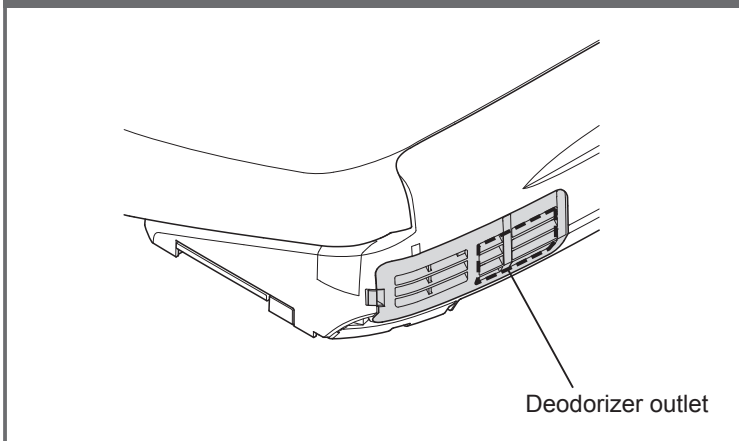

Deodorizer outlet

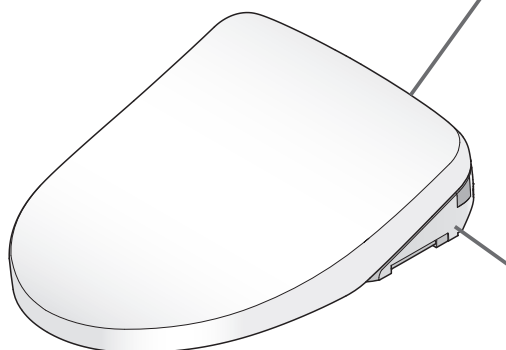

Left side of main unit

Water filter drain valve (Page 41)

"Auto flush" function plug socket<sup>\*2</sup>

Cover

For SW\*\*\*\*T40

For SW\*\*\*\*

Soft light<sup>\*3</sup>

Right side of main unit

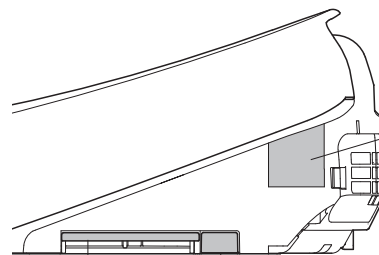

Remote control receiver

Main unit removal button (Pages 38, 39)

Deodorizing filter (Page 36)

\*1 The shape and location vary depending on the type of toilet bowl and tank.

\*2 Only used when "FLUSH" button is located on the top side of the remote control.

\*3 Only used on models with "Soft light" function.

# Parts Names

SW3054AT40, SW3054  
 SW3044AT40, SW3044

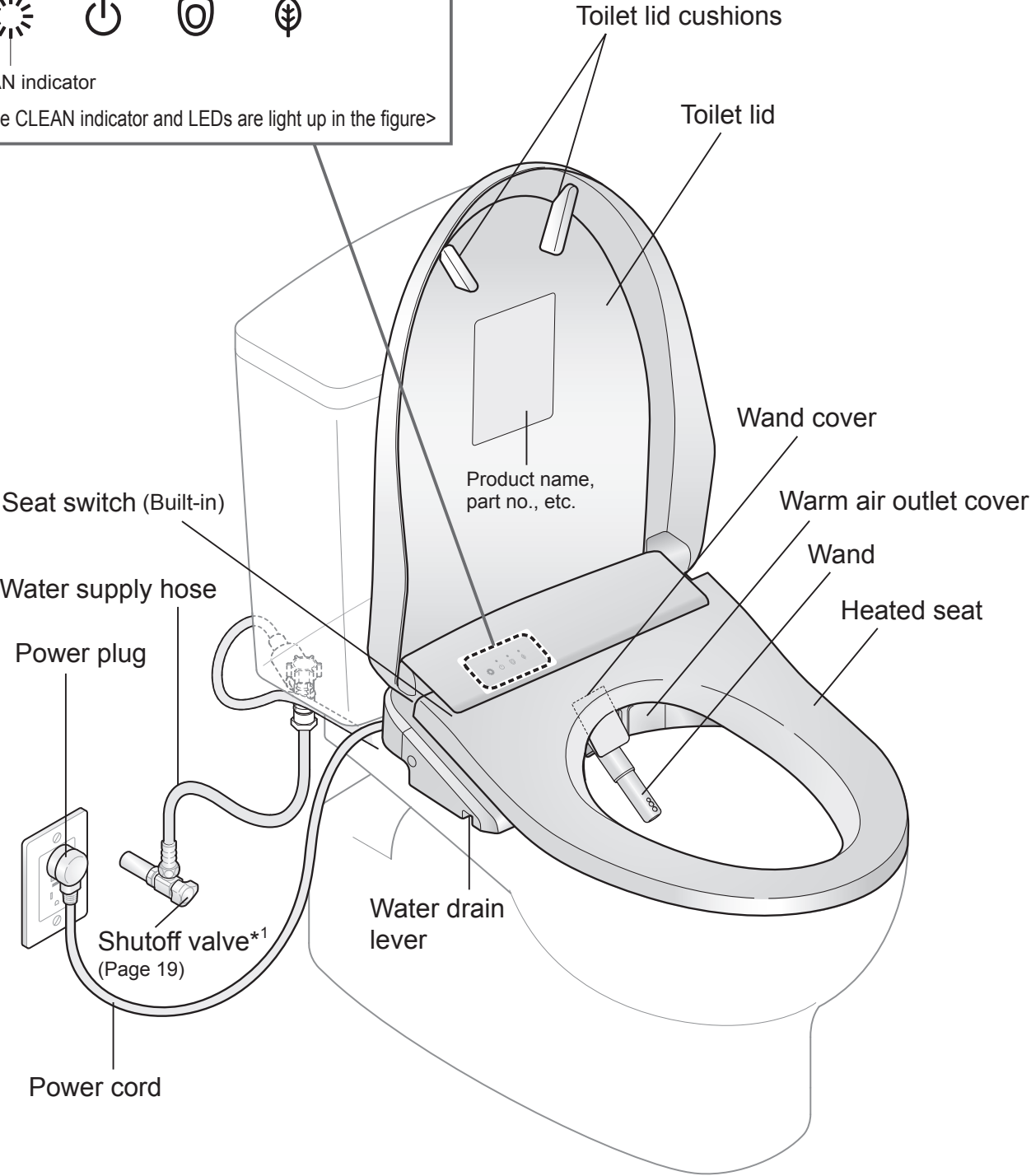
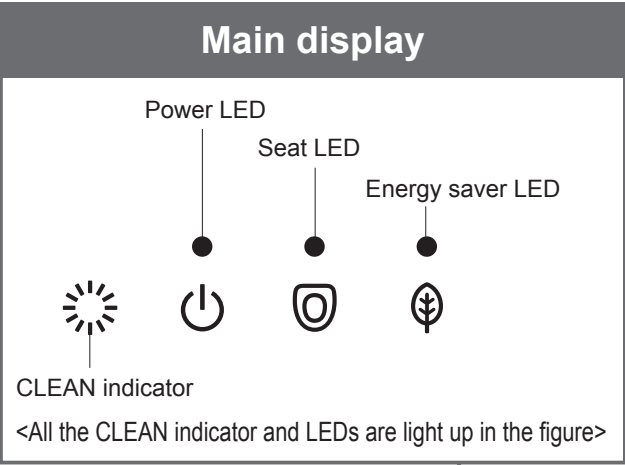

<Illustration shows SW3054>



Toilet seat cushions

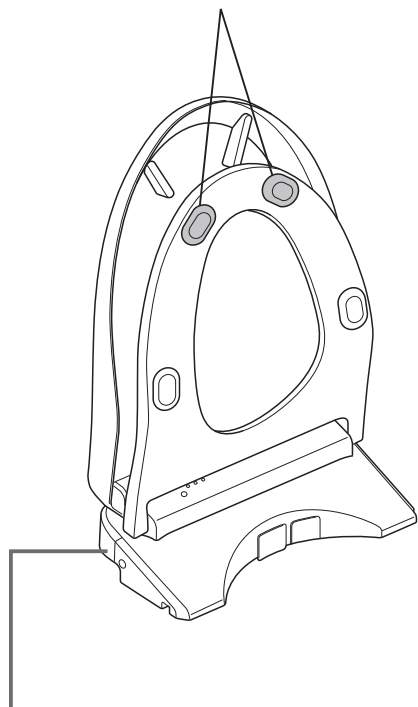

**Right rear of main unit**

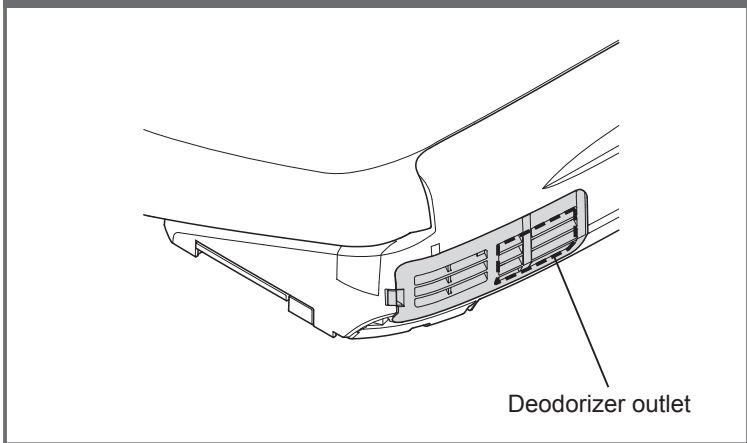

Deodorizer outlet

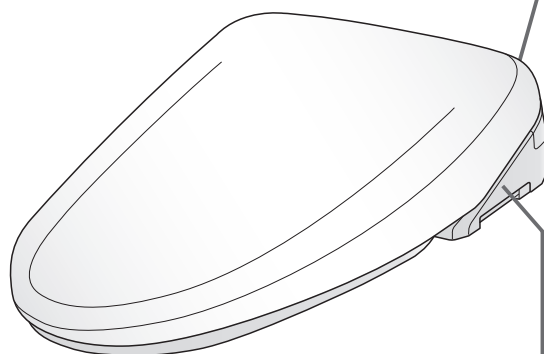

**Left side of main unit**

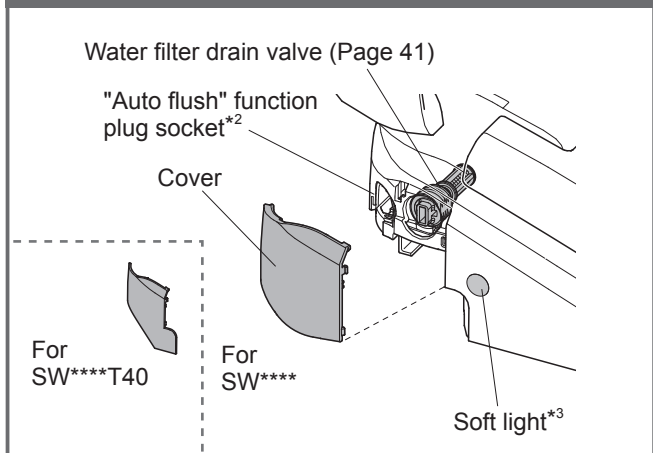

Water filter drain valve (Page 41)

"Auto flush" function plug socket\*2

Cover

For SW\*\*\*\*T40

For SW\*\*\*\*

Soft light\*3

**Right side of main unit**

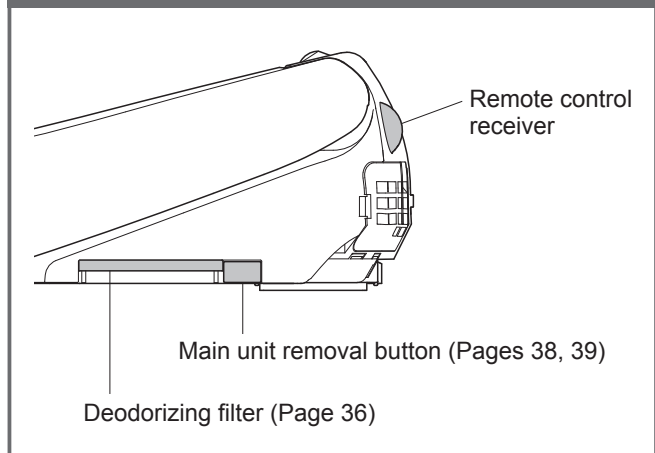

Remote control receiver

Main unit removal button (Pages 38, 39)

Deodorizing filter (Page 36)

\*1 The shape and location vary depending on the type of toilet bowl and tank.

\*2 Only used when "FLUSH" button is located on the top side of the remote control.

\*3 Only used on models with "Soft light" function.

# Preparation

## Using the Product for the First Time

### 1. Insert the battery

- 1 Remove the remote control from the hanger.

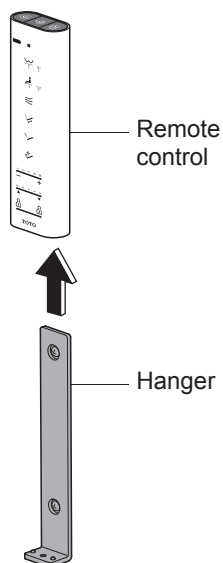

- 2 Open the battery cover and insert two AA batteries.

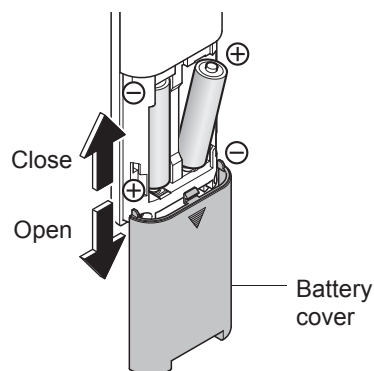

- When batteries are properly inserted, temperature levels appear on the display of the remote control (back side).  
→ When the temperature levels are not displayed, perform step 3 of "Language Settings" in page 56.
- The display goes out when no button on the remote control is pressed for about 60 seconds or more.

- 3 Mount the remote control in the hanger.

#### ■ About the batteries

- Use dry cell, alkaline batteries.
- Be sure to follow "Safety Precautions" to prevent the batteries from rupturing or leaking fluid, etc. (Pages 7, 8)

### If the remote control is secured (for anti theft)

- 1 Remove the screw from the remote control fixture.

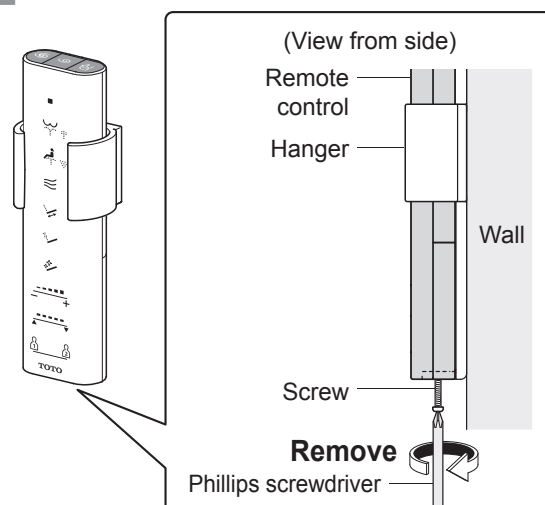

- 2 Remove the remote control from the hanger.

#### ■ To secure the remote control again

Tighten and fix the screw.  
(Overtightening may cause damage to parts such as the hanger.)

## 2. Turn on the power

**1** Insert the power plug.  
• The wand extends and then retracts.

**2** Check that the "Power" LED lights up.

• When it is off, switch the "Power" to "ON".

**To operate from the back of remote control**

 Press "Power ON/OFF" button about 3 seconds or longer.

**To operate from the front of remote control**

\* Recommended if the remote control is secured to prevent theft.

 Press "Oscillating cleansing" button about 10 seconds or longer.

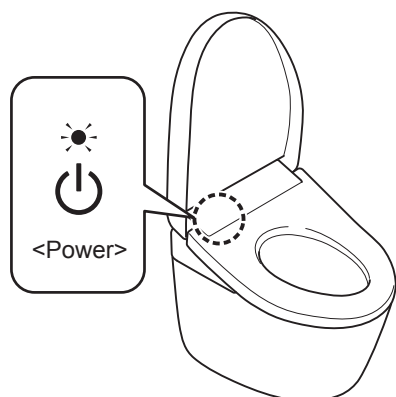

### To turn the power "OFF"

Perform the same operation as step 2 above

• The "Power" LED goes off.

## 3. Open the shutoff valve

**1** Fully open the shutoff valve.

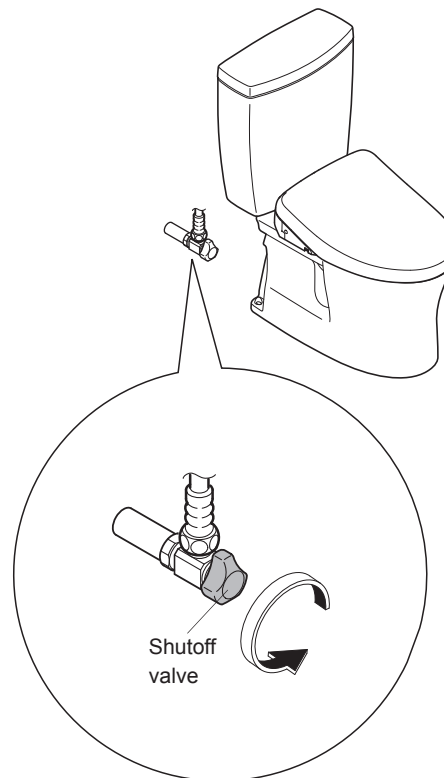

# Basic Operations

Operate the controls on the remote control; a beep sounds when the main unit receives the signal.

**■ The flush buttons**  
The type of button varies depending on the type of toilet bowl or tank.

**Full flush/ Light flush**

**Full flush**

**Toilet flush button not included**

**TOTO**

**Flushing\*1**

"Full flush"  
Performs a full flush.

"Light flush"  
Performs a light flush.

---

**Opening and closing\*2**

"Opening and closing the toilet seat"  
Opens and closes the toilet seat.

---

**Stopping**

"Stopping"  
Stops the operation.

---

**Cleansing**

"Rear cleansing"  
Cleanses your rear.

"Rear soft cleansing"  
Cleanses your rear with soft embracing water flow.

• The setting changes between and each time the is pressed.

---

"Front cleansing"  
Serves as a bidet for ladies.

"Wide front cleansing"  
Gently cleanses a wide area.

• The setting changes between and each time the is pressed.

---

**Drying**

"Warm air drying"  
Dries your rear.

---

"Wand CLEAN"  
Cleans the wand with ewater+  
• The wand can be automatically cleaned when you use the cleansing functions (Rear cleansing, Front cleansing, etc.). (Page 24)

● Functions that operate when a button is pressed during "Rear cleansing", "Rear soft cleansing", "Front cleansing" or "Wide front cleansing".

**Note**

● Sitting back on the toilet seat makes it easier to adjust the wand position and to reduce splashing.

"Oscillating cleansing"  
The wand moves back and forth to cleanse your rear thoroughly.  
• The setting changes between "ON" and "OFF" each time the button is pressed.

---

"Pulsating cleansing"  
Cleanses with the water pressure pulsating between soft and strong.  
• The setting changes between "ON" and "OFF" each time the button is pressed.

- The "Water pressure adjustment", "Wand position adjustment" and "Personal setting lock" functions are swipe operated.

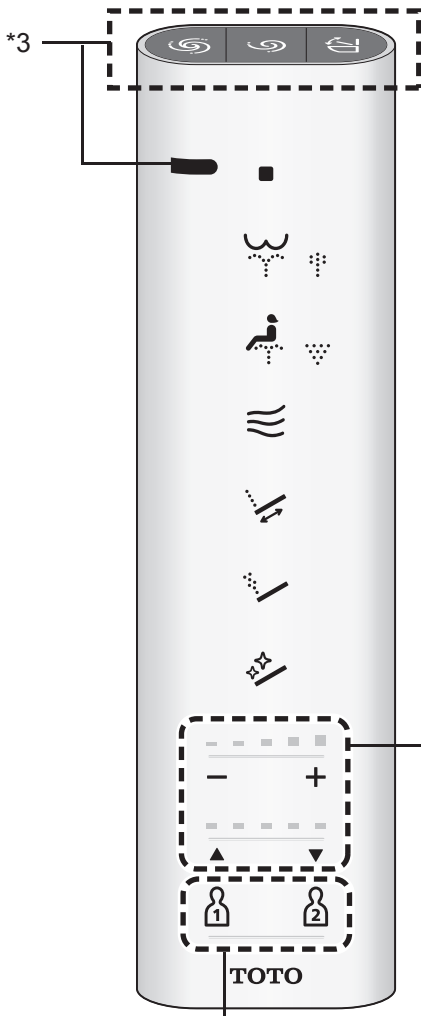

### "Personal setting lock"

You can store your preferred "Water pressure", "Wand position" and "Warm water temperature" settings.

- To store a settings → Page 60
- To use

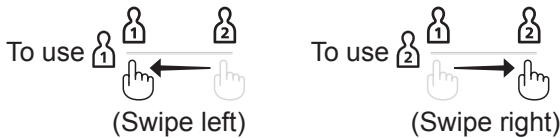

Select or and press the button for the cleansing you want to use.

- The "Wand position" and "Water pressure" lamps will light up for about 10 seconds in their set positions, and the "Water temperature" display switches.

\*1 Available only when "FLUSH" button is located on the top side of the remote control.

\*2 Except SW3046AT40, SW3046, SW3044AT40, SW3044

\*3 Remote control transmitter (Front side, Top side)

- Functions that operate when a button is pressed during "Rear cleansing", "Rear soft cleansing", "Front cleansing" or "Wide front cleansing".

#### Note

- Sitting back on the toilet seat makes it easier to adjust the wand position and to reduce splashing.

#### "Water pressure adjustment"

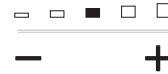

You can select from 5 levels of water pressure.

- The setting changes by one level whenever you swipe to the left or right.

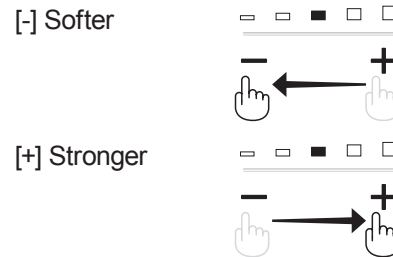

- After you swipe to change the "Water pressure adjustment" setting, the set position will light for 10 seconds.
- A light will also flash for about 10 seconds to indicate the current setting when any of the cleansing buttons (rear cleansing, rear soft cleansing, front cleansing, wide front cleansing) are pressed.



#### "Wand position adjustment"



You can select from 5 levels of wand position between the front and the rear, using the [▲] and [▼] buttons.

- The setting changes by one level whenever you swipe to the left or right.

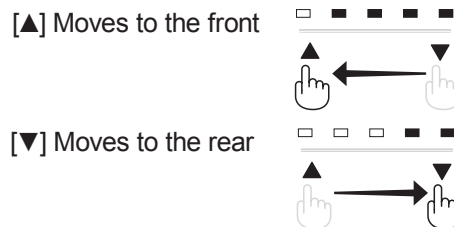

- After you swipe to change the "Wand position adjustment" setting, the set position will light for 10 seconds.
- A light will also flash for about 10 seconds to indicate the current setting when any of the cleansing buttons (rear cleansing, rear soft cleansing, front cleansing, wide front cleansing) are pressed.



# Basic Operations

## About the Menu Screen

This section is an overview of the settings that can be configured with the remote control.  
 ● See the corresponding pages for the detailed descriptions.

### Remote control back side

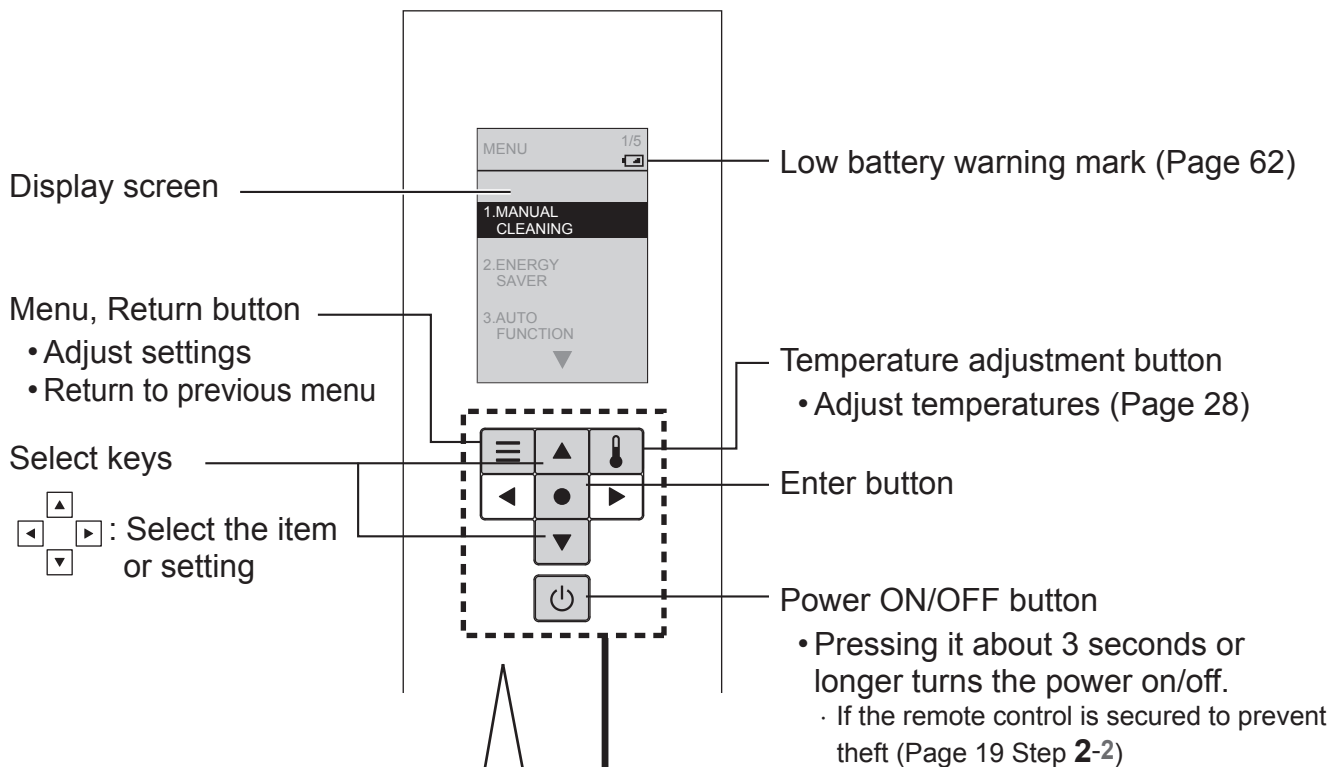

**1** Press.

- The display screen changes.

**2** Set the item from the display screen.

You can move the buttons (Up/Down) to select the item or setting.

- The letters of the selected item will be highlighted.

When [MANUAL CLEANING] is not chosen		→	When [MANUAL CLEANING] is chosen	
--------------------------------------	--	---	----------------------------------	--

When you press the button, the item is entered.

### Setting lock

You can lock the settings so that you do not mistakenly operate the rear buttons while using the remote control.

**How to Set (Page 58)**

Display screen during setting lock

You can set as desired

If you want to return to the previous item, press the  button.

Operation

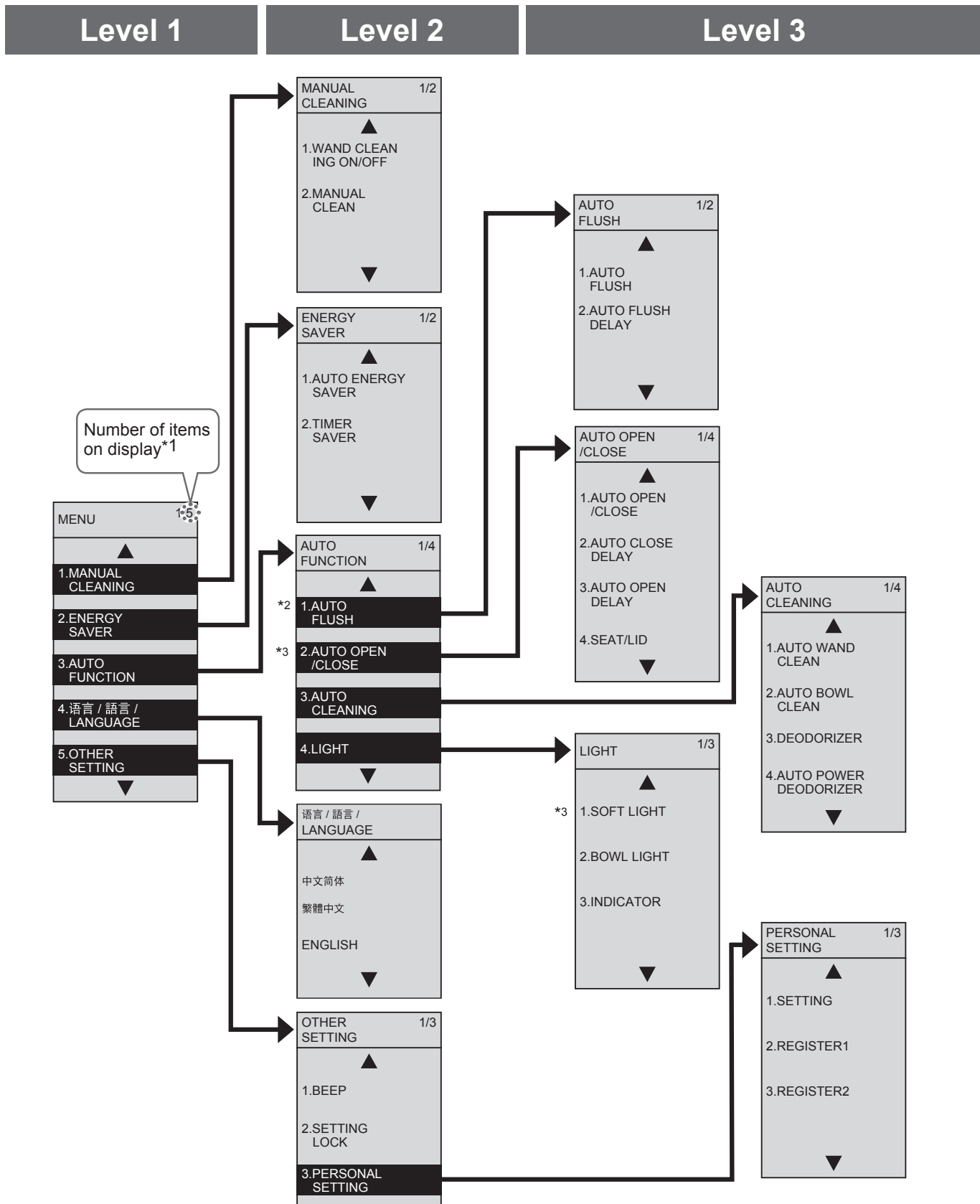

\*1 The setting items and numbers vary according to the model.

\*2 Available only when "FLUSH" button is located on the top side of the remote control.

\*3 Except SW3046AT40, SW3046, SW3044AT40, SW3044

# Automatic Functions

## Cleaning Features

"ewater+"<sup>\*1</sup> is used automatically to clean the wand and bowl unit.

- Operation under the initial settings is described below.

**As you approach**



**As you sit \*2**



**As you stand up**



<p>Removing odors inside the bowl unit</p> <p><b>Deodorizer</b></p>	<p>Starts the deodorizer</p>		<p>Starts the auto power deodorizer (After about 10 seconds)</p> <p>→ It stops after about 60 seconds</p>
<p>Cleans the wand with "ewater+"<sup>*1</sup></p> <p><b>Auto wand CLEAN</b></p>			<p>Cleans the wand automatically (After about 25 seconds)</p> <p>Only when the cleansing functions are used.</p> <p>→ The wand extends and "ewater+"<sup>*1</sup> comes out from the base of the wand</p>
<p>Cleans the bowl unit with "ewater+"<sup>*1</sup></p> <p><b>Auto bowl CLEAN</b></p>	<p>Pre-mist</p> <p>→ A mist is sprayed inside the bowl unit to make it more difficult for dirt to adhere</p>		<p>After-mist (After auto wand CLEAN)</p> <p>If the cleansing functions are not used, after-mist starts after about 25 seconds.</p> <p>→ "ewater+"<sup>*1</sup> mist is sprayed on the bowl unit</p>
<p><b>Bowl light</b></p>	<p>Lights up during pre-mist</p>		<p>Lights up during auto wand CLEAN and after-mist</p>
<p><b>CLEAN indicator</b></p>	<p>(Lights up)</p>	<p>(Lights up in a cycle)</p>	



Lights to show that the "CLEAN" functions are operating.

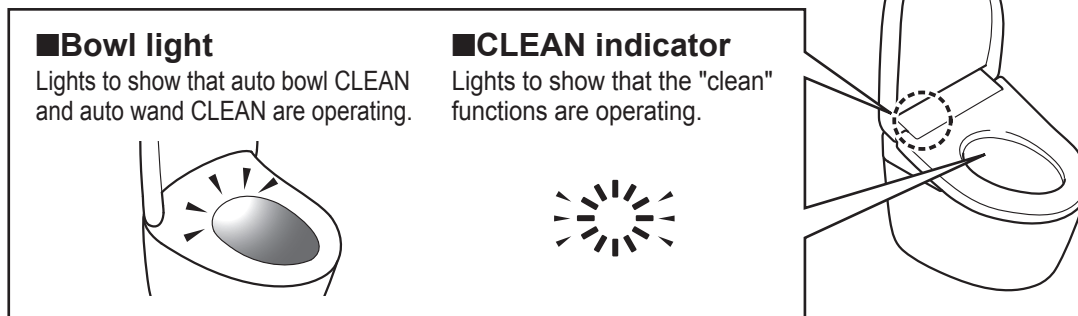

■ **Bowl light**

Lights to show that auto bowl CLEAN and auto wand CLEAN are operating.

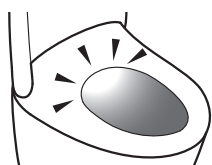

■ **CLEAN indicator**

Lights to show that the "clean" functions are operating.



■ **Note**

■ **Changing settings**

"ewater+" can also be used by pressing the remote control button

Operation

• **Deodorizing filter needs regular maintenance.** (Page 36)

- "Deodorizer" ON/OFF
- "Auto power deodorizer" ON/OFF (Page 52 for all)

■ **For wand**



Press "Wand CLEAN" button

(After wand cleaning, water comes out from around the wand.)

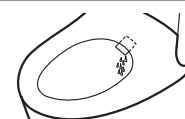

- To clean the wand with it extended. → "Wand cleaning" (Page 37)

• When the cleansing functions (Rear and Front cleansing etc.) have not been used in 8 hours, the wand is cleaned automatically. (Water comes out from around the wand.)

- "Auto wand CLEAN" ON/OFF (Page 50)

■ **For bowl unit ( [MANUAL CLEAN] )**

1



Press.

2



Select [MANUAL CLEANING].



Press.

3



Select [MANUAL CLEAN].



Press.

("ewater+" mist is sprayed on the bowl unit)

**Note**

- It cannot be used when the wand is out or when you are sitting on the toilet seat.

• The pre-mist and after-mist are not sprayed if the toilet seat is open.  
 • The pre-mist does not work for about 90 seconds after the after-mist has finished.  
 • When the cleansing feature (Rear and Front cleansing etc.) is not used for about 8 hours, mist is sprayed on the bowl unit automatically.

- "Auto bowl CLEAN" ON/OFF (Page 50)

- "Bowl light" ON/OFF (Page 54)

• Lights up continuously or in a cycle when "Auto wand CLEAN", "Auto bowl CLEAN" or "Auto power deodorizer" is operating. (Lights only when the toilet seat is not in-use)

- "CLEAN indicator" ON/OFF (Page 54)

\*1 What is meant by "ewater+" ?

"ewater+" helps the self-cleaning wand feature working effectively and preventing the dirt accumulation causing the stains.

- "ewater+" is generated from potable water.
- "ewater+" helps to minimize dirty surfaces, but does not make cleaning unnecessary.
- The effect and duration vary depending on the usage environment and conditions.

\*2 Water comes out from the area around the wand for several seconds while water is warmed up.

# Automatic Functions

## Convenience Features

Various automatic functions are available.

- Operation under the initial settings is described below.

### As you approach \*1



### As you sit



### As you stand up



Flush automatically  
**Auto flushing\*2**

When using the toilet seat



The toilet flushes  
(After about 10 seconds)

When standing and using

Opening the toilet lid automatically  
**Auto open / close\*3**

When using the toilet seat

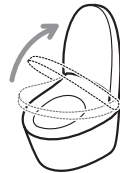

The toilet lid opens

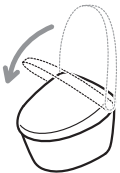

The toilet lid closes  
(After about 90 seconds)

When standing and using

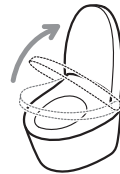

The toilet lid opens



Open the toilet seat with the remote control.

Lighting up the inside of the bathroom with a soft light  
**Soft light\*3**

Lights up in middle mode

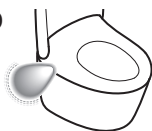

Lights up in high mode



Lights up in middle mode

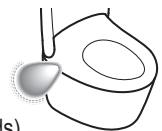

(About 90 seconds)

\*1 Detection by the body sensor may be difficult when the toilet is used by someone small, such as a child.

\*2 Available only when "FLUSH" button is located on the top side of the remote control.

\*3 Except SW3046AT40, SW3046, SW3044AT40, SW3044

\*4 For models SW3046AT40 and SW3044AT40, auto flushing will not be activated when the user uses the toilet in standing position.

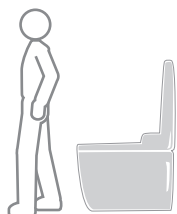

\*5 A full flush will be used depending on the type of bowl unit.

## As you move away



### ■ Note

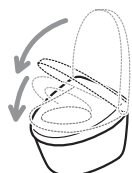

### ■ Changing settings

	<ul style="list-style-type: none"> <li>• Auto flush is not available in the following cases.                     <ul style="list-style-type: none"> <li>→ About 60 seconds after the toilet is flushed. (After 60 seconds have passed, flush using the remote control.)</li> <li>When the time spent sitting on the toilet seat or standing in front of the bowl unit is less than about 6 seconds. (Flush with the remote control.)</li> </ul> </li> <li>• The flushing varies depending on how long you sit on the toilet seat.                     <ul style="list-style-type: none"> <li>Around 6 to 30 seconds: "Light flush"*5</li> <li>Around 30 seconds or more: "Full flush"</li> </ul> </li> <li>• Depending on factors such as the location of the toilet, it may take up to about 20 seconds for light flush to start when using standing up.</li> </ul>	<ul style="list-style-type: none"> <li>• "Auto flushing" ON/OFF</li> <li>• "Auto flush delay" (5 seconds, 10 seconds or 15 seconds) (Page 44 for all)</li> </ul>
 <p><b>The toilet flushes*4</b> (Performs a "Light flush" about 3 seconds after the user has moved about 1.3 ft (about 40 cm) away from the bowl unit.)*5</p>		
<p>... →</p>  <p><b>The toilet lid and toilet seat close</b> (About 90 seconds after moving away from the bowl unit by about 1.3 ft (about 40 cm) or more.)</p>	<ul style="list-style-type: none"> <li>• When the toilet lid is closed by hand, it cannot open automatically for about 15 seconds. (Open and close by hand.)</li> <li>• When you do not sit on the toilet seat, or when you sit on it or stand in front of the bowl unit briefly, it takes about 5 minutes before the lid closes automatically.</li> </ul>	<ul style="list-style-type: none"> <li>• "Auto open/close" ON/OFF</li> <li>• "Auto close delay" (25 seconds or 90 seconds) (Page 46)</li> <li>• "Auto open delay" (15 seconds, 30 seconds or 90 seconds)</li> <li>• Seat/lid (Lid/Seat · Lid) (Page 48)</li> </ul>
<p>... →</p> <p><b>Lights up in low mode</b> (Goes out after about 5 seconds)</p> 		<ul style="list-style-type: none"> <li>• "Soft light" ON/OFF (Page 54)</li> </ul>

# Temperature Adjustment

Warm Water, Toilet Seat, Drying

Five different temperature levels from high to low and "OFF" can be set.

- 1 Remove the remote control from the hanger.
  - If the remote control is secured to prevent theft (Page 18)
- 2  Press.
- 3   Select the item you want to set.

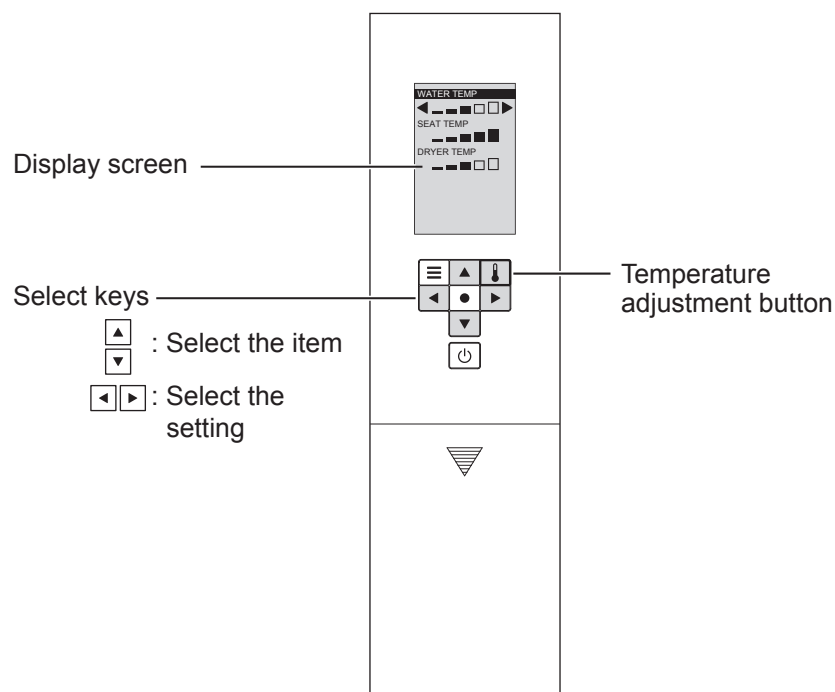
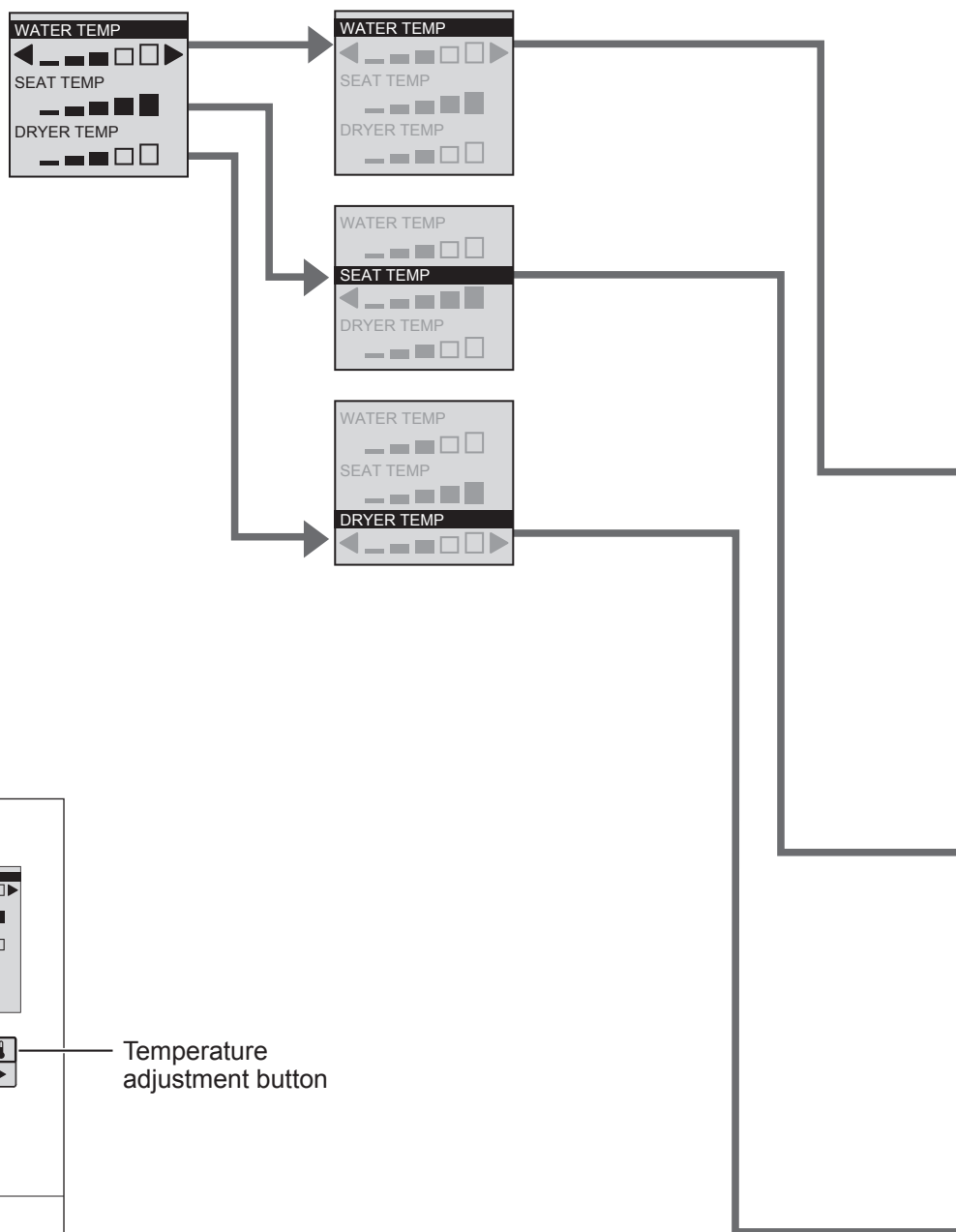

**CAUTION**

● During setting, the display goes out when no button is pressed within about 60 seconds. If you fail to complete the setting, redo from the step 2.

**4**  Select the temperature level.

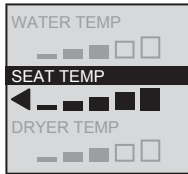

<Settings complete>

**5** Mount the remote control in the hanger.

- If the remote control is secured to prevent theft (Page 18)

**Warm water temperature**

Press  until [OFF] appears.

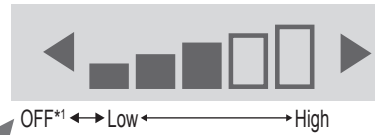

**Toilet seat temperature**

Press  until [OFF] appears.

- When "OFF" is set, the "SEAT" LED on the main display will go off.

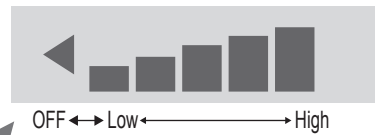

**Drying air temperature**

- The "Drying" cannot be turned "OFF".

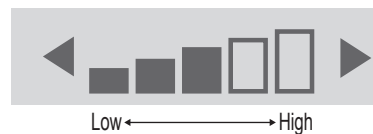

\*1 To prevent condensation, the water temperature does not drop below 20°C even when set to "OFF".

● If adjusting the temperature does not warm up the toilet seat → Is "Energy saver" set to "ON"? (Page 32)

# Energy Saver Features

**Type**

"Auto energy saver", "Auto energy saver+" or "Timer energy saver" can be selected. To save energy, the temperature of the toilet seat becomes low (or "OFF").

● "Auto energy saver" takes about 10 days to detect time periods in which the toilet seat is never or infrequently used.

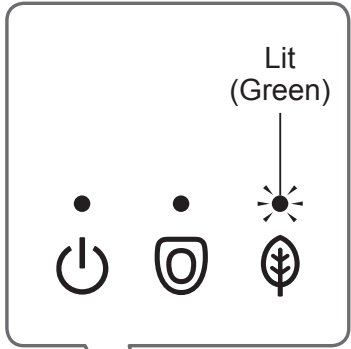
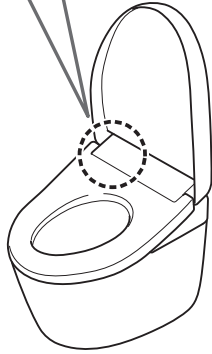
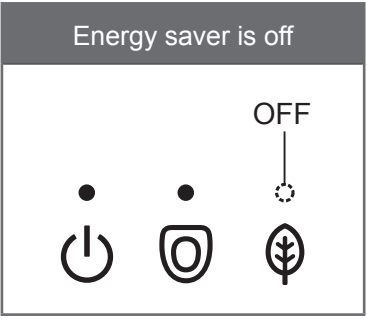
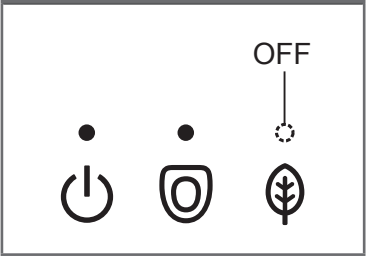
Type	Situation	Energy saver is on	
		Main display	
<b>Auto energy saver</b>	<p>You want the product to save energy automatically.</p> <p>The product detects time periods with infrequent use and lowers the toilet seat temperature automatically.</p>		
<b>Auto energy saver+</b>	<p>You want to save more energy</p> <p>In addition to the auto energy saver feature, it automatically turns off the toilet seat heater during time periods when the toilet is never used.</p>		
<b>Timer energy saver</b>	<p>You want to save energy only for the preset duration of time. (6 hours, 9 hours)</p> <p>Once the time is set, the toilet seat heater turn off automatically during the set time period every day.</p>	<p>Energy saver is off</p> 	
<b>Timer energy saver + Auto energy saver / Auto energy saver+</b>	<p>You want to save a lot of energy with auto energy saver and timer energy saver.</p> <p>When <b>both</b> "Timer energy saver" and "Auto energy saver / Auto energy saver+" are set, Auto energy saver / Auto energy saver+ operates when "Timer energy saver" is not operating.</p>		

● Even if the energy saver feature is on (i.e., the toilet seat heater is set to "Low" or "OFF"), the toilet seat is heated to the set temperature in about 15 minutes. (The LED indication on the main display returns to the state for when the energy saver is on.)

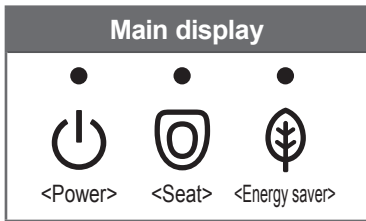

When energy saver is in operation		AM		PM				
Toilet seat heater		0	4	6	8	5	9	0
		Example: Used infrequently from 9 pm to 6 am 						
		Example: Not used from 0 am to 4 am 						
		Example: Set from 8 am to 5 pm 						
<ul style="list-style-type: none"> <li>● During "Auto energy saver / Auto energy saver+": Same LED indication as "Auto energy saver / Auto energy saver+" (see above)</li> <li>● During "Timer energy saver": Same LED indication as "Timer energy saver" (see above)</li> </ul>		Example: When "Timer energy saver" and "Auto energy saver+" are used together 						

Operation

\*1 The toilet seat temperature set on page 28.  
 \*2 The time period when the toilet seat heater is set to a "Low".  
 \*3 The time period when the toilet seat heater is set to a "OFF".

To set energy saver Page 32 and 33

# Energy Saver Features

## How to Set

Set the "Timer energy saver" at the time you want to start it.

**1**  Press.

**2**   Select [ENERGY SAVER].

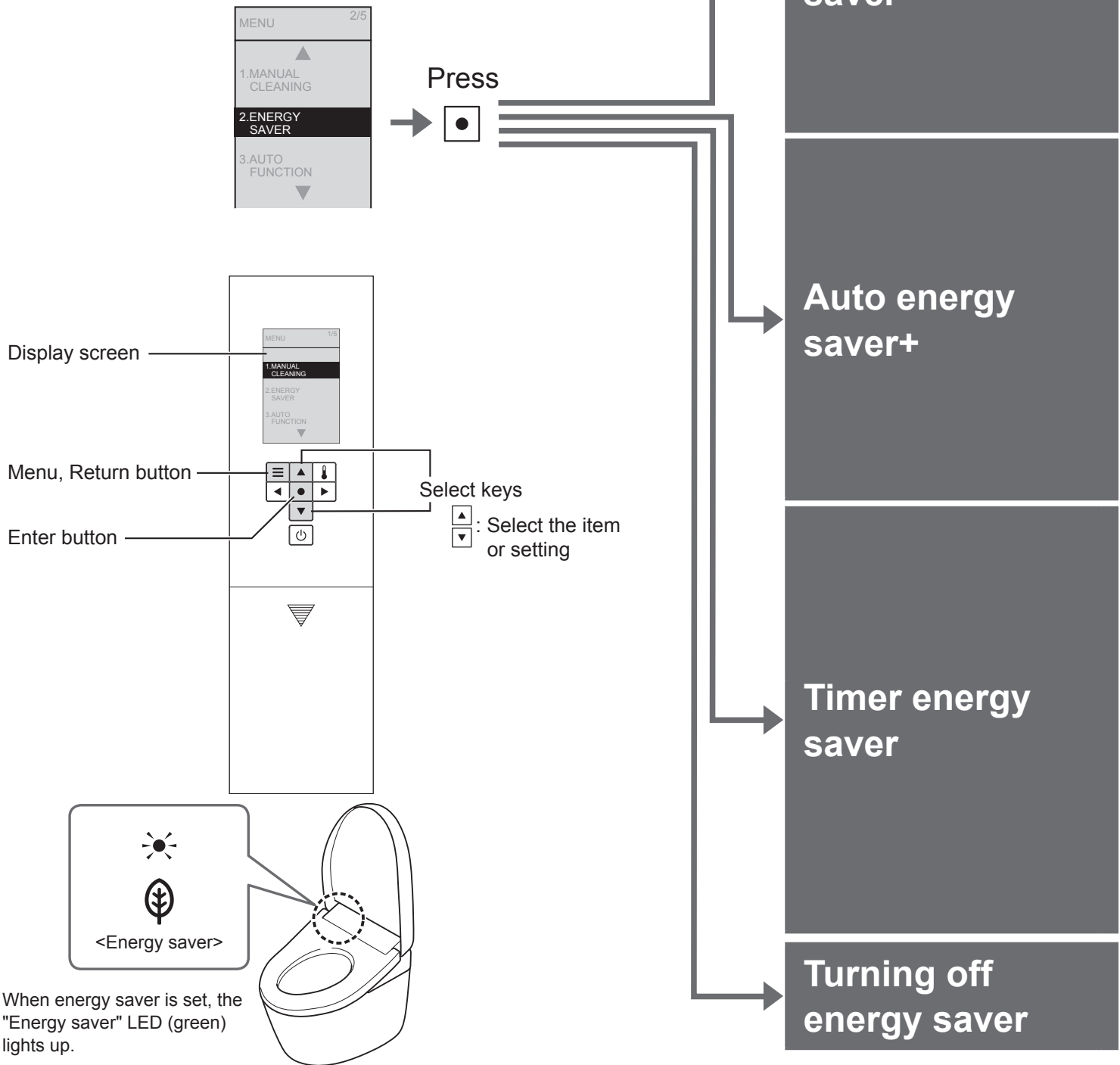

### CAUTION

- During setting, the display goes out when no button is pressed within about 60 seconds. If you fail to complete the setting, redo from the step 1.



**3** Select  
[AUTO ENERGY SAVER].

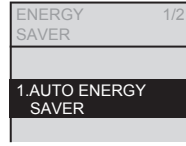

Press

**4** Select  
[AUTO ENERGY SAVER].

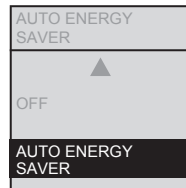

Press →

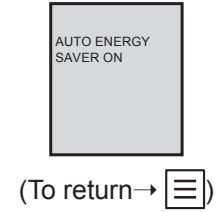

**3** Select  
[AUTO ENERGY SAVER].

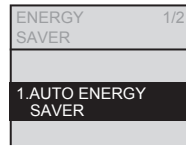

Press

**4** Select  
[AUTO ENERGY SAVER+].

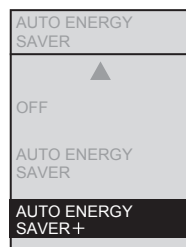

Press →

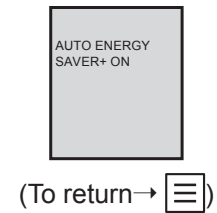

**3** Select  
[TIMER SAVER].

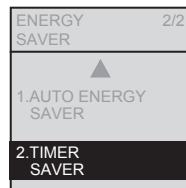

Press

**4** Select  
[6H], [9H] or [OFF].

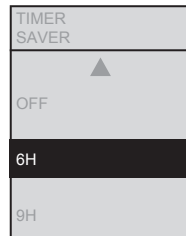

Press →

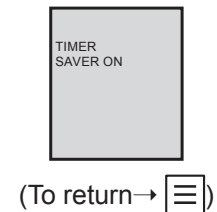

■ To change the timer energy saver time → Set the timer energy saver again at the time you want to start it.

Select [OFF] in step 4 in each procedure above and then press .

# Maintenance

## Power Plug

### Power Plug (Approximately once a month)

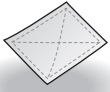

Dry cloth



Wet cloth

- 1 Unplug the power plug and wipe it with a dry cloth.



- 2 Insert the power plug.
  - The "Power" LED lights up.

### WARNING

- Periodically remove dust from the blades and other parts of the power plug.
  - Unplug the power plug and wipe it with a dry cloth.
- Fully insert the power plug.
- When unplug the power plug, hold the main body of the power plug.
  - Pulling the power cord may damage the power plug or power cord.



### WARNING

- Always unplug the power plug from the outlet before maintenance or inspection. (Failure to do so may cause electric shock or malfunction, resulting in a breakdown.)

For safety, unplug the power plug before maintenance.\*1

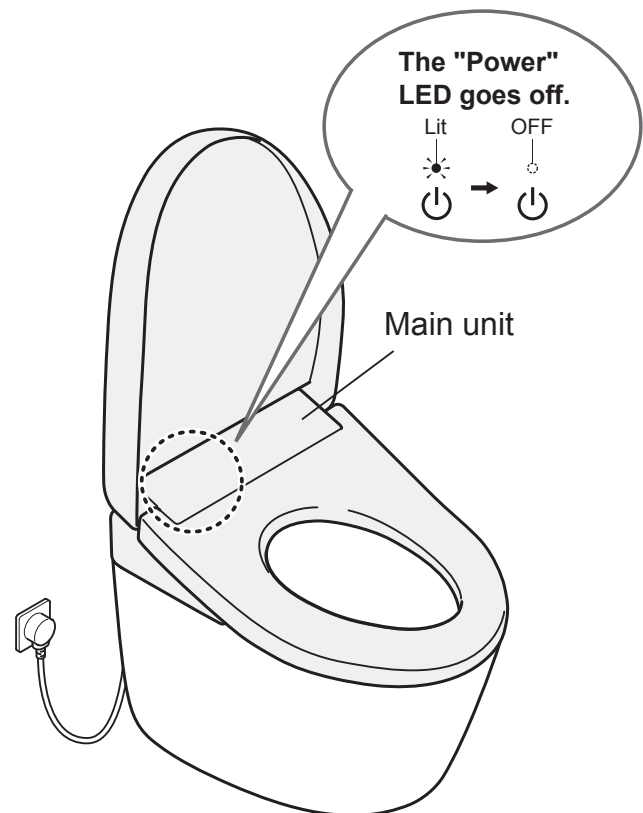

Do not use a dry cloth or toilet paper on plastic parts.

(May cause damage.)

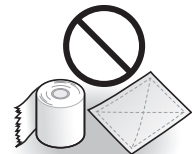

\*1 Except when using "Wand cleaning".

\*1 After the power plug is inserted, the toilet lid does not open automatically for about 10 seconds. (Because it is preparing for operation.)

Open and close by hand.

(Except SW3046AT40, SW3046, SW3044AT40, SW3044)

## Main Unit

### Main Unit (Approximately daily)



Soft cloth soaked in water



- Toilet paper
- Dry cloth
- Nylon scrubbing brush (May cause damage.)

1

Unplug the power plug.

2

Wipe with a soft cloth that has been soaked in water and wrung-out thoroughly.

■ For heavy dirt

- Wipe with a soft cloth soaked in diluted, neutral kitchen detergent, and then wipe with a soft cloth soaked in water.



· Neutral kitchen detergent



- Paint thinner
- Benzene
- Powdered cleanser

3

Insert the power plug.

- The "Power" LED lights up.

Attention!

- This product is an electric appliance. Be careful not to let water seep inside or leave detergent in the gap between the main unit and bowl unit. (May damage plastic parts or cause a malfunction.)
- When using a toilet cleaner to clean the toilet, rinse it off within 3 minutes and leave the toilet seat and toilet lid open.
  - Wipe off any cleaner that remains on the bowl unit. (If vapor from a toilet cleaner enters the main unit, it may cause a malfunction.)
- Do not push or pull the covers around the wand with undue force.  
(May cause damage or malfunction.)
- Wipe the back surface of the toilet seat and the toilet seat cushions with a soft cloth tightly wrung out with water.  
(Otherwise adhesion of dirt may result in discoloration.)

## Deodorizing Filter

### Deodorizing Filter (Approximately once a month)

**1** Unplug the power plug.

**2** Remove the deodorizing filter.

- Hold the knob and pull outward.
- Do not pull with undue force.  
(May cause damage or malfunction.)

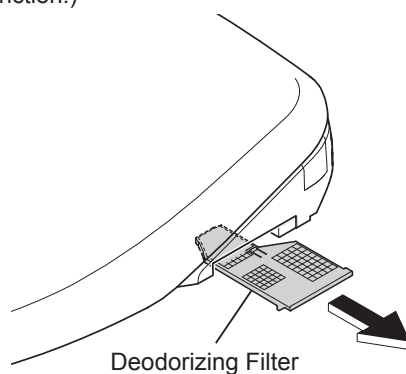

**3** Clean with a tool such as a toothbrush.

- When washing with water, dry off all water before mounting.

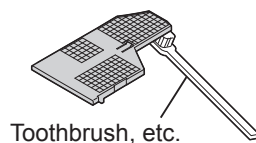

**4** Mount the deodorizing filter.

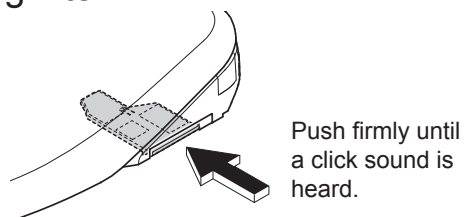

**5** Insert the power plug.

- The "Power" LED lights up.





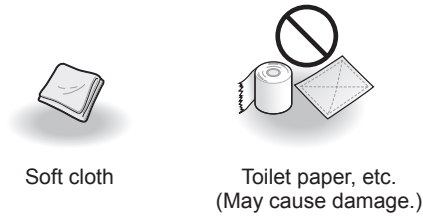

# Wand

## Wand (Approximately once a month) <If you notice dirt (Wand cleaning)>





### 1 Extend the wand.

#### To operate from the back of remote control

- (1)  Press.
- (2)  Select [MANUAL CLEANING]. →  Press.  

- (3)  Select [WAND CLEANING ON/OFF]. →  Press.  

#### To operate from the front of remote control

- Recommended if the remote control is secured to prevent theft.
- (1)  Press "Stopping" button about 10 seconds or longer.
    - All the indicators on the remote control flash,  
or an electronic sound is heard from the main unit.
  - (2)  Press "Front cleansing" button about 3 seconds or longer.
- The wand extends and water sprays out for cleaning.
  - The wand automatically retracts after about 5 minutes.

### 2 Wipe with a soft, wet cloth.

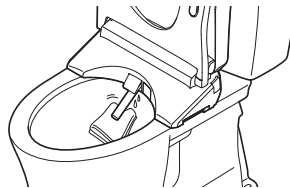
- Do not pull, push or press the wand with excessive force.  
(May cause malfunctions or damage.)



### 3 Press "Stopping" button on the front side of the remote control.

- The wand retracts.

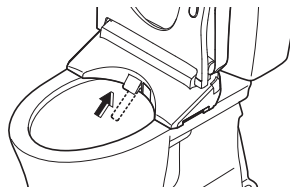

# Maintenance

## Gap between the Main Unit and Bowl Unit

{SW3056AT40, SW3046AT40, SW3054AT40, SW3044AT40}

### Gap between the Main Unit and Bowl Unit (Approximately once a month)

You can remove the main unit to clean the top of the bowl unit and the bottom of the main unit.

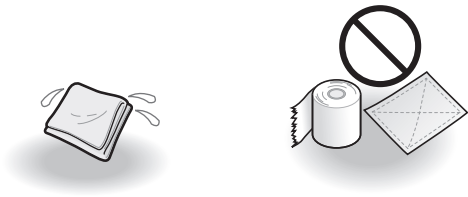

Soft cloth soaked in water    Toilet paper, etc. (May cause damage.)

**1** Unplug the power plug.

**2** Remove the main unit.

- Do not pull the unit with undue force (because the water supply hose and power cord are attached).
- (1) Pull the main unit toward you while pressing the "Main unit removal button".
- (2) Lift up the main unit.

• Do not excessively bend the water supply hose.

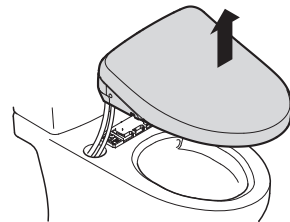
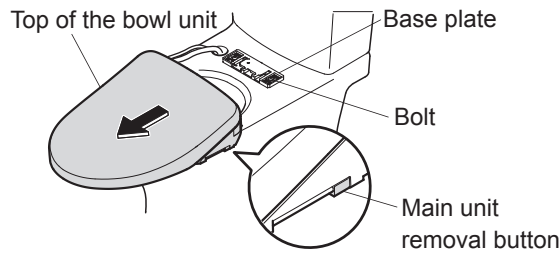

**3** Clean the top of the bowl unit and the bottom of the main unit.

- Wipe with a soft cloth soaked in a diluted, neutral kitchen detergent. Then, wipe it with a soft cloth soaked in water so that no detergent remains.

**4** Mount the main unit.

- (1) Lift the main unit, then lower it straight down while threading the power cord and water supply hose into the recess on the bowl unit.

- Be careful not to pinch the power cord.
- Do not excessively bend the water supply hose.

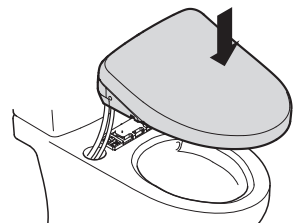

- (2) Align the main unit with the center of the base plate and press it firmly onto the base plate until a click sound is heard

**CAUTION**

**!** Push the main unit firmly on to the base plate until a click sound is heard. (Failure to do so could cause the main unit to come loose and fall resulting in injury.)

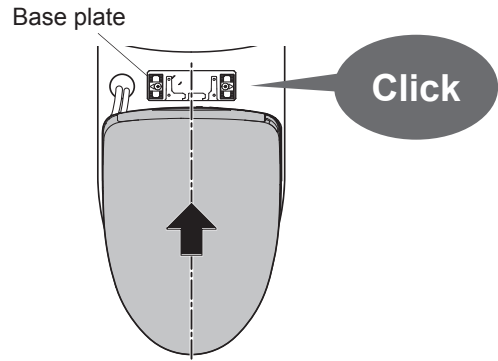

After mounting, check that the main unit does not detach even when pulled.

**5** Insert the power plug.

- The "Power" LED lights up.

{SW3056, SW3046, SW3054, SW3044}

## Gap between the Main Unit and Bowl Unit (Approximately once a month)

You can remove the main unit to clean the top of the bowl unit and the bottom of the main unit.

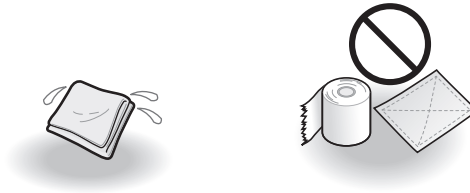

Soft cloth soaked in water      Toilet paper, etc. (May cause damage.)

**1** Unplug the power plug.

**2** Remove the main unit.  
• Do not pull the unit with undue force (because the water supply hose and power cord are attached).

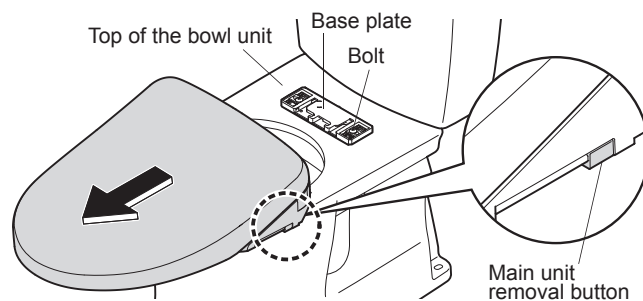

**Pull the main unit toward you while pressing the "Main unit removal button".**

**3** Clean the top of the bowl unit and the bottom of the main unit.  
• Wipe with a soft cloth soaked in a diluted, neutral kitchen detergent. Then, wipe it with a soft cloth soaked in water so that no detergent remains.

**4** Mount the main unit.  
• Be careful not to pinch the cords between the main unit and the base plate.

**CAUTION**

**!** Push the main unit firmly on to the base plate until a click sound is heard. (Failure to do so could cause the main unit to come loose and fall resulting in injury.)

After mounting, check that the main unit does not detach even when pulled.

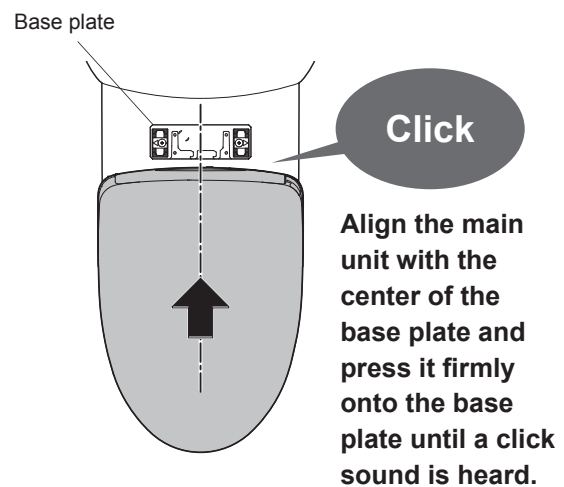

**5** Insert the power plug.  
• The "Power" LED lights up.

# Maintenance

## Gap between the Main Unit and the Toilet Lid

### Gap between the Main Unit and the Toilet Lid (Approximately once a month)

The toilet lid can be removed for thorough cleaning.



Soft cloth soaked in water

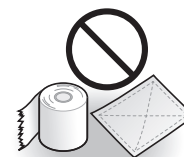

Toilet paper, etc.  
(May cause damage.)

- 1** Unplug the power plug.
- 2** Remove the main unit.  
(Pages 38, 39)
- 3** Remove the toilet lid.  
Slightly tilt the toilet lid to the front.  
↓  
(A) : Pull the left side outward.  
↓  
(B) : Disconnect the hinge from the tab and pull up.  
↓  
(C) : Disconnect the right side.
- 4** Wipe with a soft cloth that has been soaked in water and wrung-out thoroughly.
- 5** Reinstall the toilet lid.  
(D) : Join the pin and the hinge on the right side.  
↓  
Slightly tilt the toilet lid to the front.  
↓  
(A) : While pulling out the left side,  
↓  
(E) : Mount by joining the hinge with the tab.  
\* Be careful not to pinch your fingers.
- 6** Mount the main unit.  
(Pages 38, 39)
- 7** Insert the power plug.  
• The "Power" LED lights up.
- 8** Open and close the toilet lid to check the reinstallation.

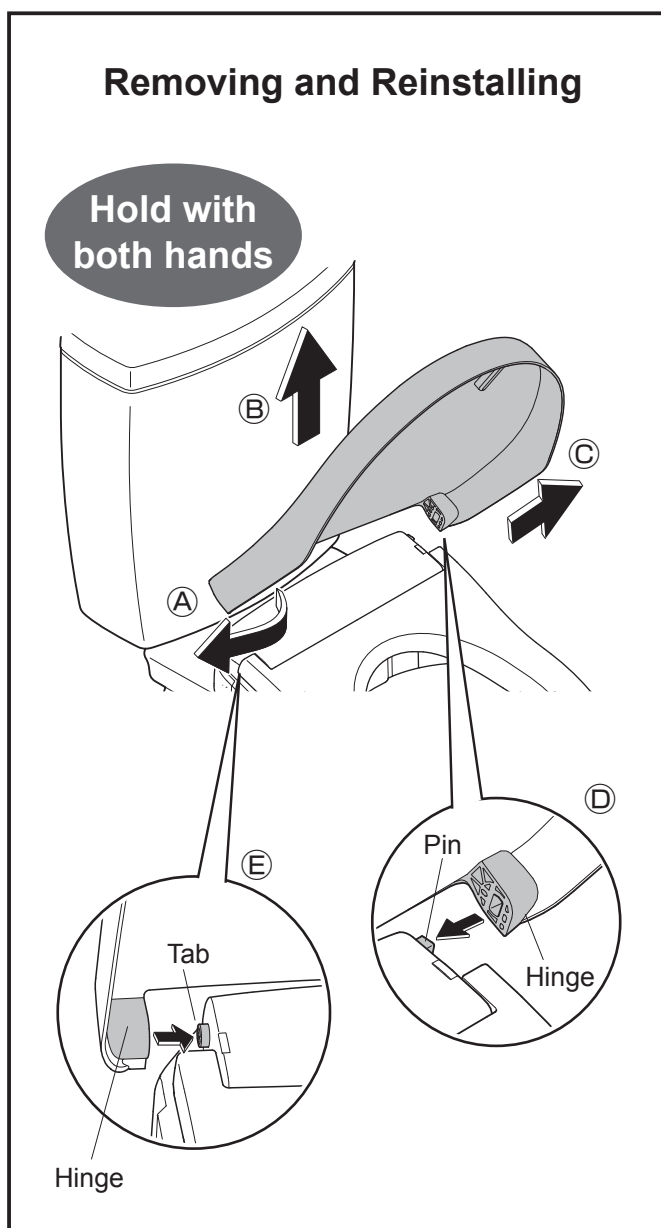



# Water Filter Drain Valve

## Water Filter Drain Valve (Approximately once every 6 months) <If you think the water pressure has weakened>

1

Close the shutoff valve.  
• The water supply stops.

**CAUTION**

 Do not remove the water filter drain valve while the shutoff valve is open.  
(Otherwise, water may leak out.)

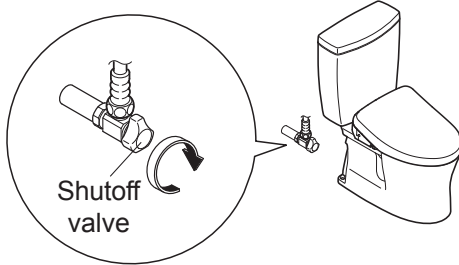

2

 Press "Wand CLEAN" button.

• Open the wand cover. (Release the pressure from the water supply pipe.)

3

Unplug the power plug.

4

Remove the cover and water filter drain valve.

• Loosen the water filter drain valve with a flat-head screwdriver and then pull it.

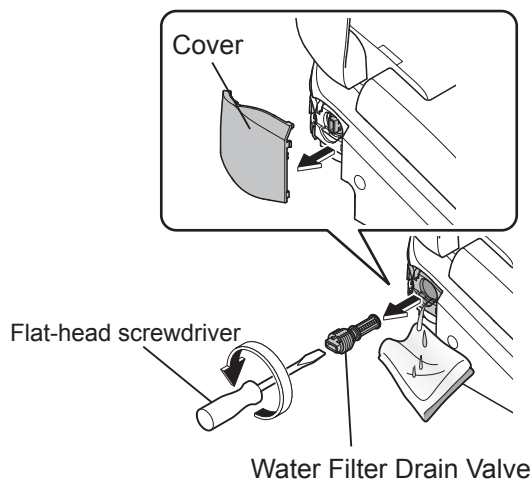

5

Clean with a tool such as a toothbrush.

• Also, remove any dust from inside the hole of the water filter drain valve.

6

Reinstall the water filter drain valve and cover.

• Insert the water filter drain valve and use a flat-head screwdriver to tighten it securely.

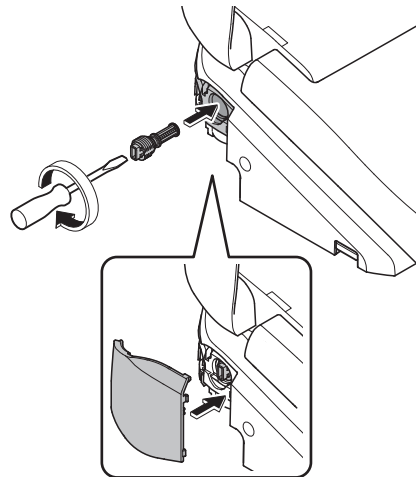

7

Insert the power plug.

• The "Power" LED lights up.

8

Open the shutoff valve.

(Page 19)

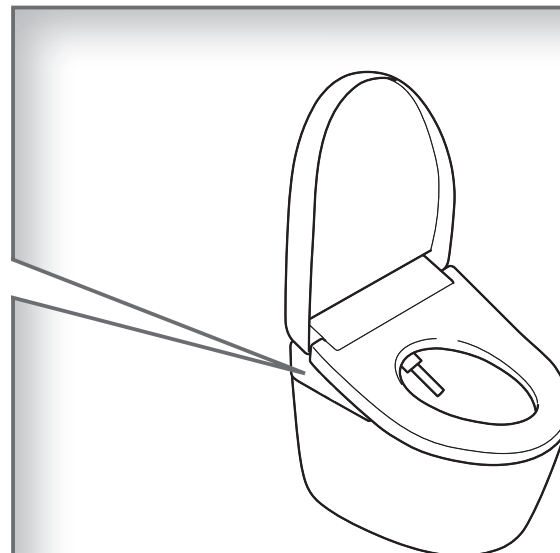

# Changing Settings

## Setting List

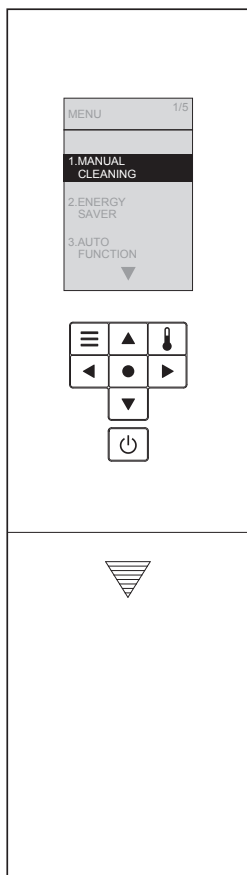

Setting Types			
Auto functions	Auto Flushing	Auto Flushing	
		Auto Flush delay	
	Auto open / close	Auto open / close	
		Auto close delay	
		Auto open delay	
		Seat/lid	
	Cleaning Features	Auto wand CLEAN	
		Auto bowl CLEAN	
		Deodorizer	
		Auto power deodorizer	
	Light	Soft light	
		Bowl light	
		CLEAN indicator	
	Language Settings		
	Other settings	Beep sound	
Setting lock			
Personal setting		Setting	
	Register1 Register2		

**CAUTION**

- During setting, the display goes out when no button is pressed within about 60 seconds. If you fail to complete the setting, redo from the step 1.

	Available Settings • Bold: Initial settings	Applicable Models	Setting Ref. Page
• Set whether or not to <b>clean the bowl unit automatically</b>	<b>ON</b> / OFF	SW3056AT40*1	Page 44
• Change the amount of time before the toilet flushes automatically	5seconds / <b>10seconds</b> / 15seconds	SW3054AT40*1 SW3046AT40*1 SW3044AT40*1	
• Set whether or not to <b>open and close the toilet lid automatically</b>	<b>ON</b> / OFF	SW3056AT40 SW3056 SW3054AT40 SW3054	Page 46
• Change the amount of time before the lid/seat closes automatically	25seconds / <b>90seconds</b>		Page 48
• Change the amount of time after which the lid/seat opens automatically upon closing it with hands	<b>15seconds</b> / 30seconds / 90seconds		
• Automatically open and close the toilet lid/ Automatically open and close the toilet seat and toilet lid	<b>Lid</b> / Seat · Lid		
• Set whether or not to <b>clean the wand automatically</b>	<b>ON</b> / OFF	All models	Page 50
• Set whether or not to <b>spray mist in the bowl unit automatically</b>	<b>ON</b> / OFF		Page 52
• Set whether or not to <b>deodorize automatically after sitting on the toilet seat</b>	<b>ON</b> / OFF		
• Set whether or not to <b>power deodorize automatically after standing up</b>	<b>ON</b> / OFF		
• Set whether or not to <b>use the soft light</b>	<b>ON</b> / OFF	SW3056AT40 SW3056 SW3054AT40 SW3054	Page 54
• Set whether or not to <b>use the light inside the bowl unit</b>	<b>ON</b> / OFF	All models	Page 54
• Set whether or not to <b>light up the CLEAN indicator</b>	<b>ON</b> / OFF		
• <b>Select the language</b> displayed on the back of remote control	Simplified Chinese / Traditional Chinese / English	All models	Page 56
• Set whether or not to <b>make a beep sound</b>	<b>ON</b> / OFF		Page 58
• Set whether or not to <b>use the setting lock</b>	<b>ON</b> / OFF		
• Set whether or not to <b>use the personal setting</b>	<b>ON</b> / OFF		Page 60
• Set to <b>remember your favorite pressure, wand position and water temperature settings</b>	Register1 / Register2		

\*1 Available only when "FLUSH" button is located on the top side of the remote control.

# Changing Settings

## Auto flushing

1  Press.

2   Select  
[AUTO FUNCTION].

3   Select  
[AUTO FLUSH].

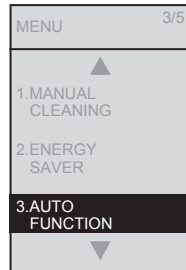

Press 

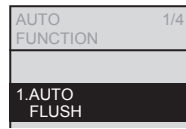

Press 

Set whether or not to clean the bowl unit automatically  
**Auto flushing**

Change the amount of time before the toilet flushes automatically  
**Auto flush delay**

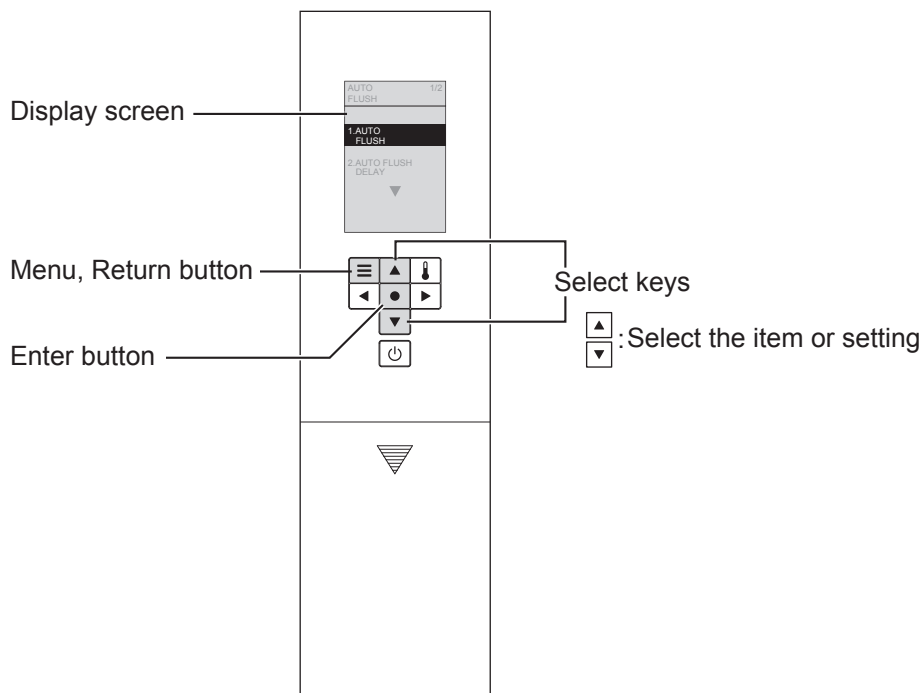

### Items set on this display

1. AUTO FLUSH  
"Auto flushing"
2. AUTO FLUSH DELAY  
"Auto flush delay"

**4** ▲ Select  
▼ [AUTO FLUSH].

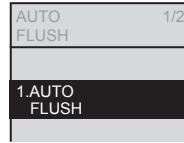

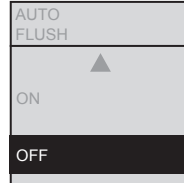

Press 

**5** ▲ Select [ON] or [OFF].  
▼



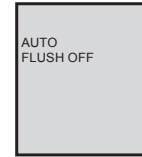

Press 

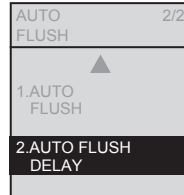

(To return → )

**4** ▲ Select  
▼ [AUTO FLUSH DELAY].



Press 

**5** ▲ Select  
▼ [5S], [10S] or [15S].

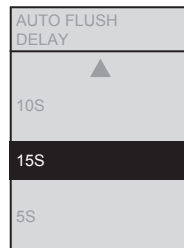

Press 

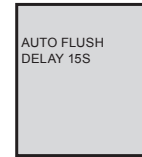



(To return → )

# Changing Settings

## Auto open / close

**1**  Press.

**2**   Select  
[AUTO FUNCTION].

**3**   Select  
[AUTO OPEN/CLOSE].

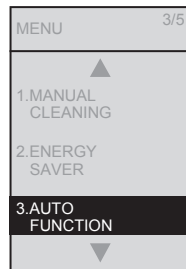

Press 

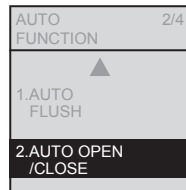

Press 

Set whether or not to open and close the toilet lid automatically  
**Auto open / close**

Change the amount of time before the lid/seat closes automatically  
**Auto close delay**

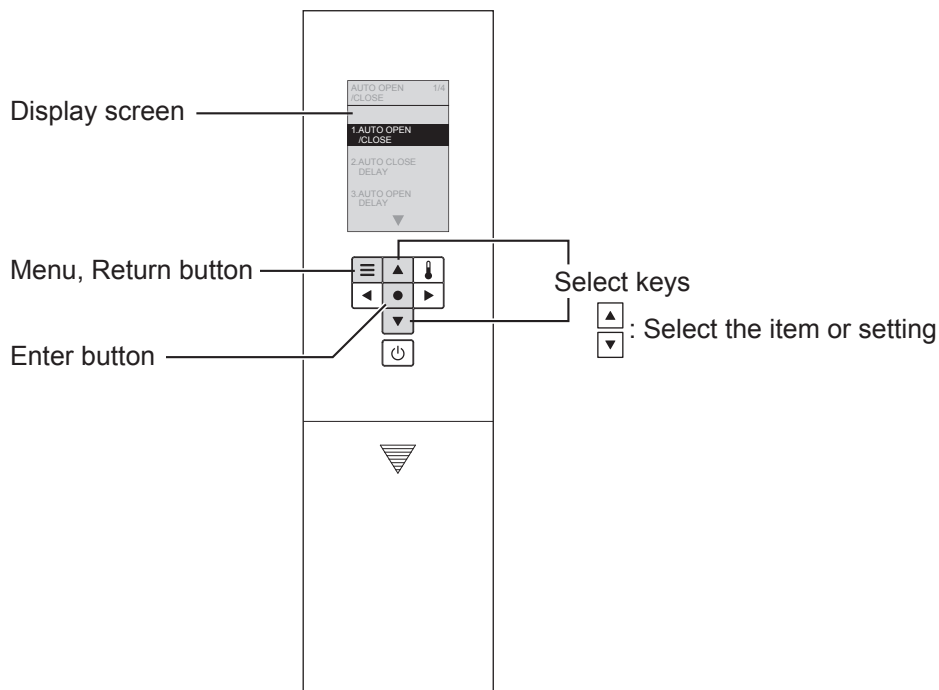

### Items set on this display

1. AUTO OPEN/CLOSE  
"Auto open/close"
2. AUTO CLOSE DELAY  
"Auto close delay"
3. AUTO OPEN DELAY  
"Auto open delay"
4. SEAT/LID  
"Seat/lid"

**4** ▲ Select  
▼ [AUTO OPEN/CLOSE].

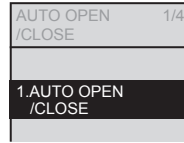

Press 

**5** ▲ Select  
▼ [ON] or [OFF].

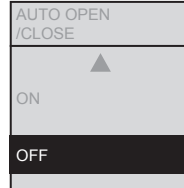

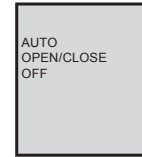

Press 

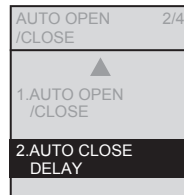

(To return → )

**4** ▲ Select  
▼ [AUTO CLOSE DELAY].



Press 

**5** ▲ Select  
▼ [25S] or [90S].\*<sup>1</sup>

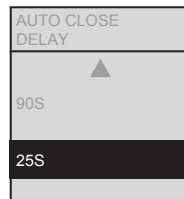

Press 

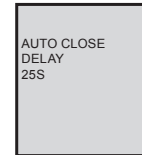

(To return → )



\*1 When set to "25 seconds", the lid/seat does not open automatically for about 15 seconds after closing automatically.

# Changing Settings

## Auto open / close (Continued)

**1**  Press.

**2**   Select  
[AUTO FUNCTION].

**3**   Select  
[AUTO OPEN/CLOSE].

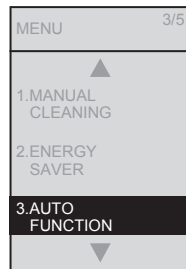

Press 

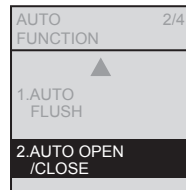

Press 

Change the time period till automatic opening (After closing by hand.)  
**Auto open delay**

Automatically open and close the toilet lid/  
Automatically open and close the toilet seat and toilet lid  
**Seat/lid**

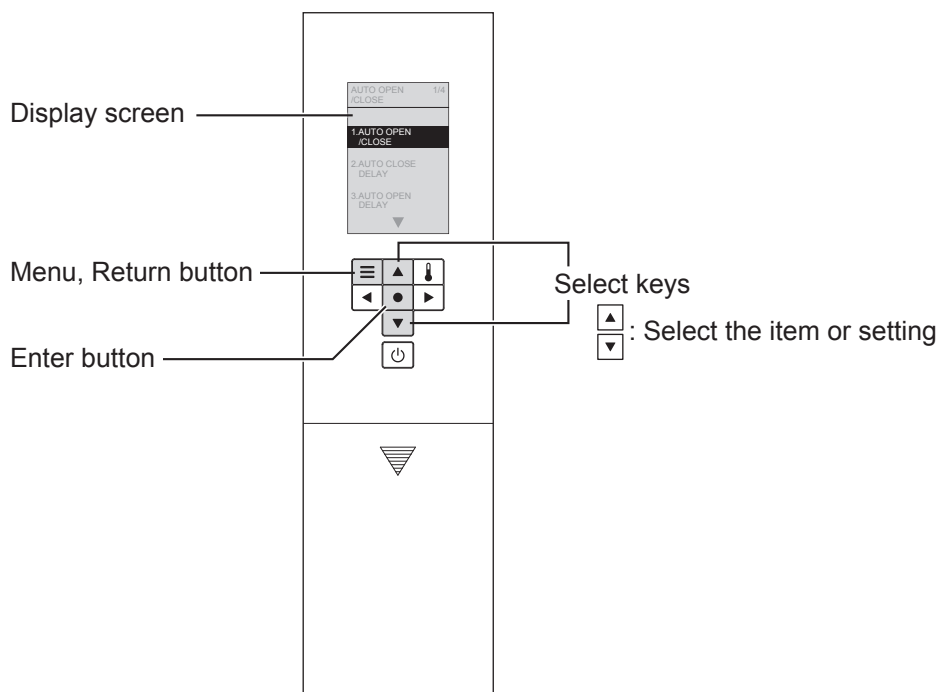

### Items set on this display

1. AUTO OPEN/CLOSE  
"Auto open/close"
2. AUTO CLOSE DELAY  
"Auto close delay"
3. AUTO OPEN DELAY  
"Auto open delay"
4. SEAT/LID  
"Seat/lid"



**4** ▲ Select  
▼ [AUTO OPEN DELAY].

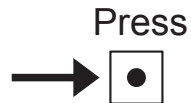
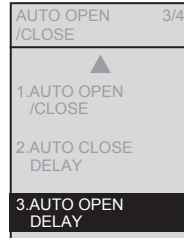

**5** ▲ Select  
▼ [15S], [30S] or [90S].

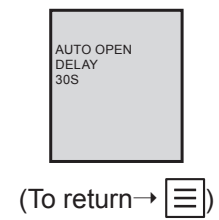
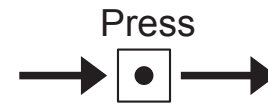
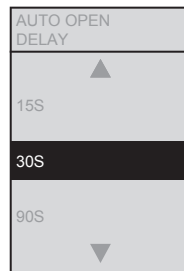

**4** ▲ Select  
▼ [SEAT / LID].

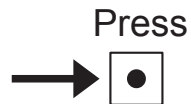
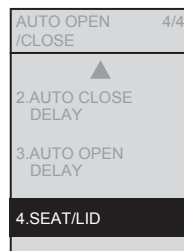

**5** ▲ Select  
▼ [LID] or [SEAT·LID].\*1

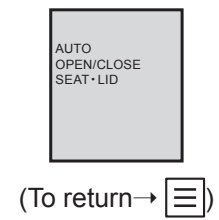
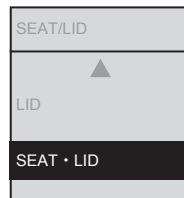



\*1 When the "Seat·lid" are set to open automatically, pre-mist is not sprayed.

# Changing Settings

## Cleaning Features

**1**  Press.

**2**   Select [AUTO FUNCTION].

**3**   Select [AUTO CLEANING].

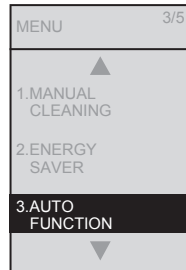

Press 

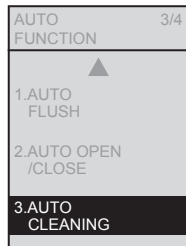

Press 

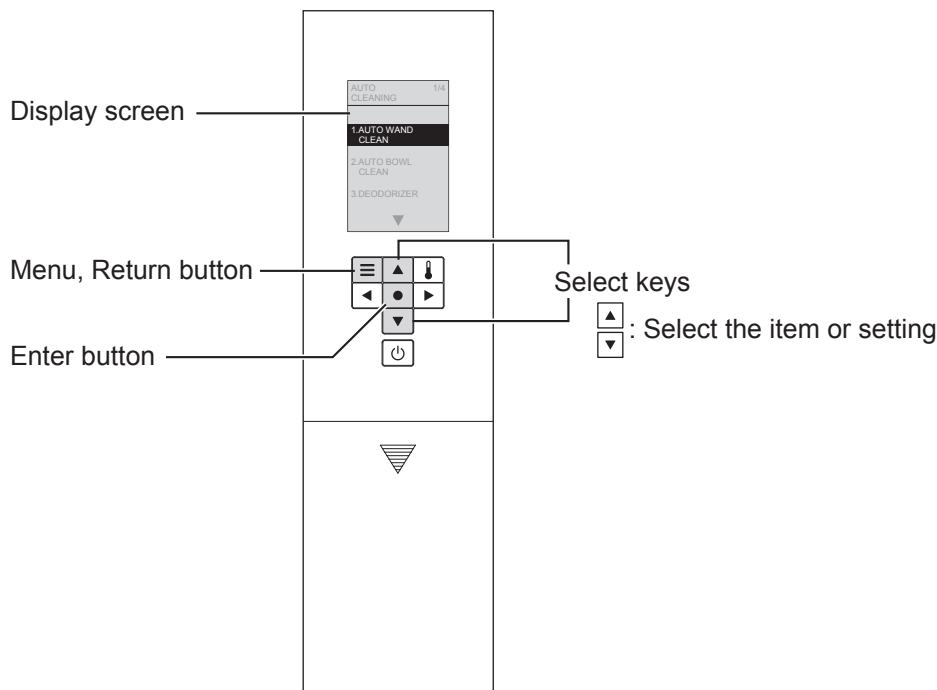

Set whether or not to clean the wand automatically  
**Auto wand CLEAN**

Set whether or not to spray mist in the bowl unit automatically  
**Auto bowl CLEAN**





### Items set on this display

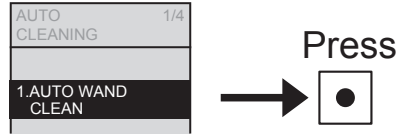

- 1. AUTO WAND CLEAN  
"Auto wand CLEAN"
- 2. AUTO BOWL CLEAN  
"Auto bowl CLEAN"
- 3. DEODORIZER  
"Deodorizer"
- 4. AUTO POWER DEODORIZER  
"Auto power deodorizer"

**4**  Select  
 [AUTO WAND CLEAN].



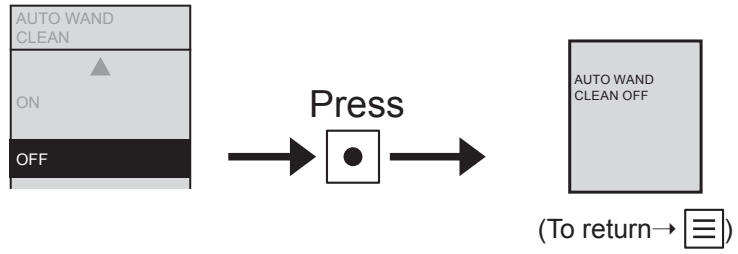

**5**  Select  
 [ON] or [OFF].

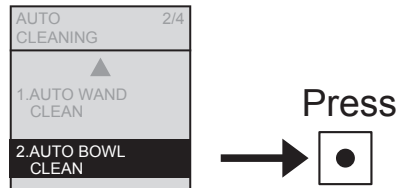

**4**  Select  
 [AUTO BOWL CLEAN].



**5**  Select  
 [ON] or [OFF].

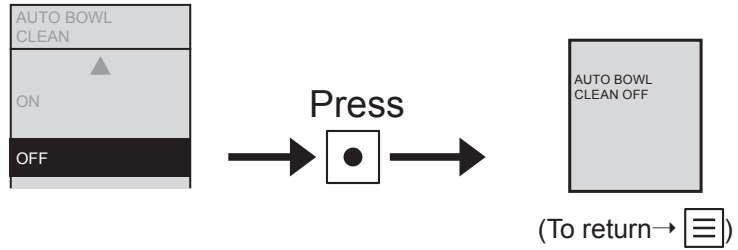

# Changing Settings

## Cleaning Features (Continued)

**1**  Press.

**2**   Select  
[AUTO FUNCTION].

**3**   Select  
[AUTO CLEANING].

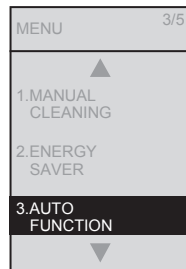

Press 

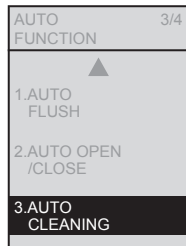

Press 

Set whether or not to deodorize automatically after sitting on the toilet seat  
**Deodorizer**

Set whether or not to power deodorize automatically after standing up  
**Auto power deodorizer**

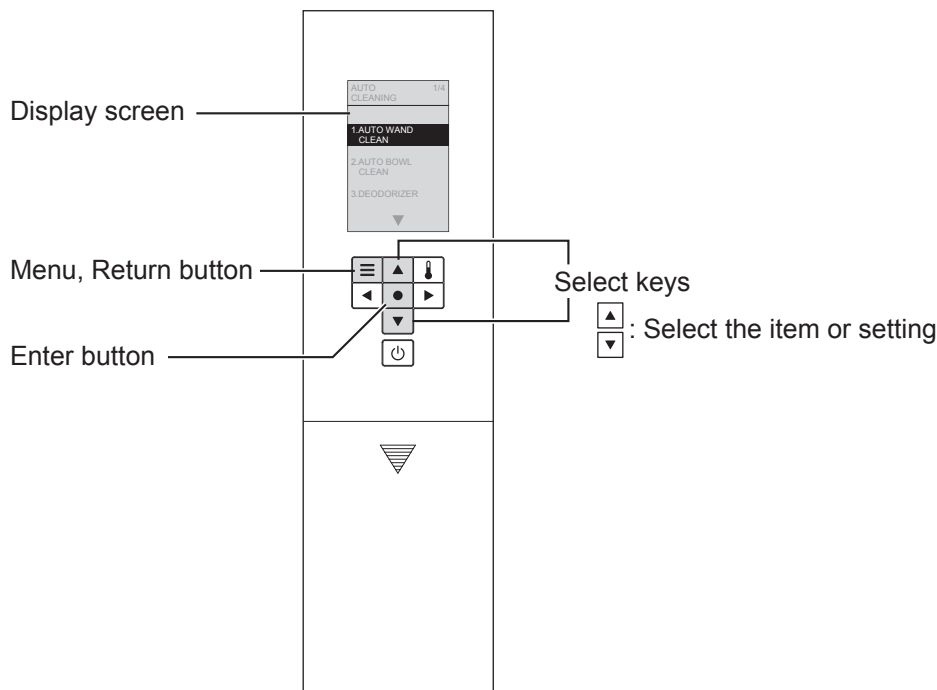



### Items set on this display

1. AUTO WAND CLEAN  
"Auto wand CLEAN"
2. AUTO BOWL CLEAN  
"Auto bowl CLEAN"
3. DEODORIZER  
"Deodorizer"
4. AUTO POWER DEODORIZER  
"Auto power deodorizer"

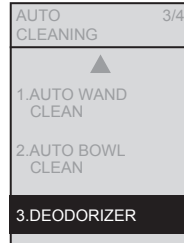
**4**  Select  
 [DEODORIZER].



Press 

**5**  Select  
 [ON] or [OFF].



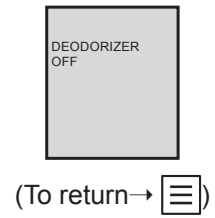

Press 

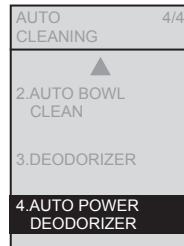

**4**  Select  
 [AUTO POWER DEODORIZER].



Press 

**5**  Select  
 [ON] or [OFF].

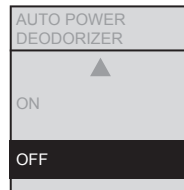

Press 

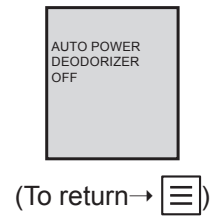

# Changing Settings

## Light

**1**  Press.

**2**   Select  
[AUTO FUNCTION].

**3**   Select  
[LIGHT].

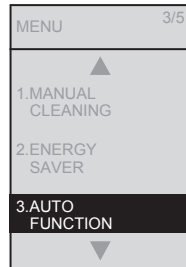

Press 

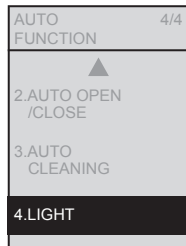

Press 

Set whether or not to use the soft light  
**Soft light**

Set whether or not to use the light inside the bowl unit  
**Bowl light**

Set whether or not to light up the CLEAN indicator  
**CLEAN indicator**

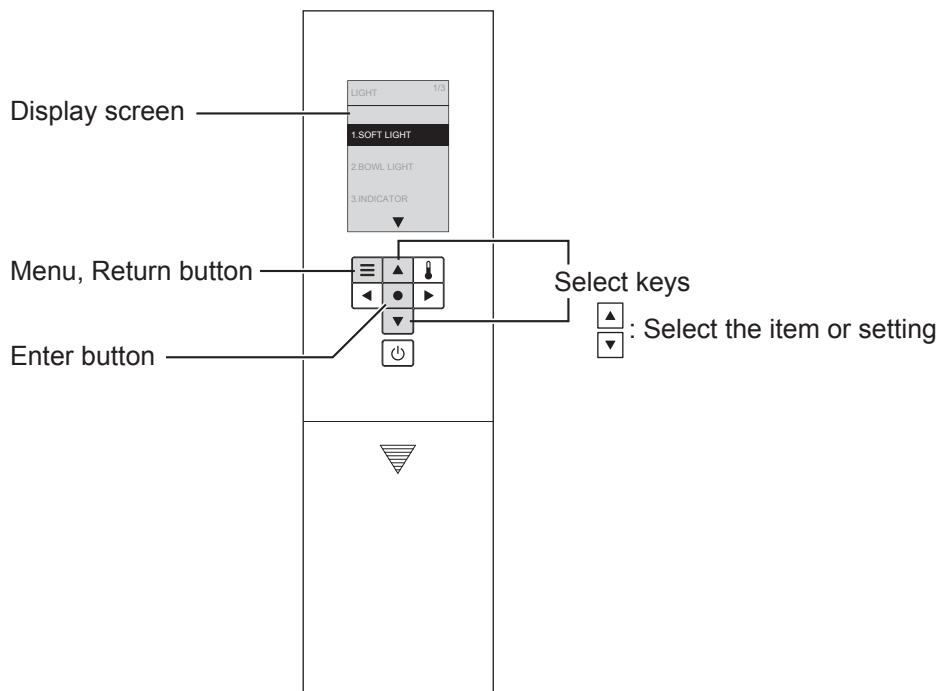



### Items set on this display

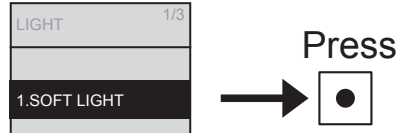

1. SOFT LIGHT  
"Soft light"
2. BOWL LIGHT  
"Bowl light"
3. INDICATOR  
"CLEAN indicator"

**4**  Select  
 [SOFT LIGHT].



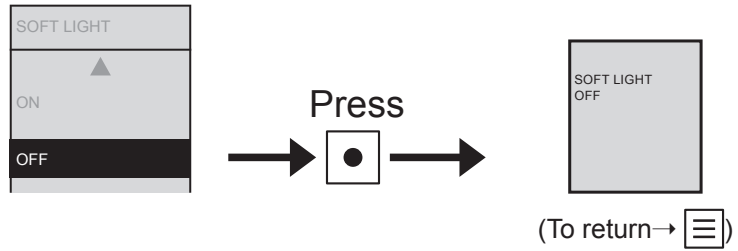

**5**  Select  
 [ON] or [OFF].

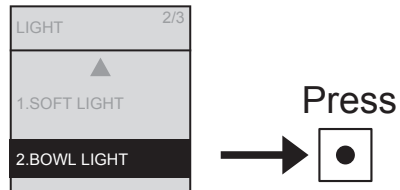

**4**  Select  
 [BOWL LIGHT].



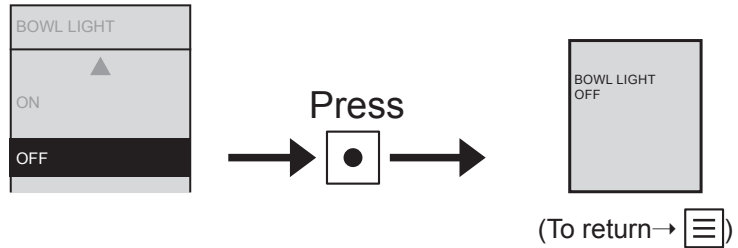

**5**  Select  
 [ON] or [OFF].

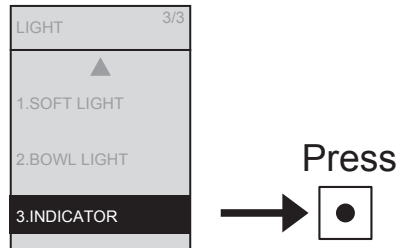

**4**  Select  
 [INDICATOR].



**5**  Select  
 [ON] or [OFF].

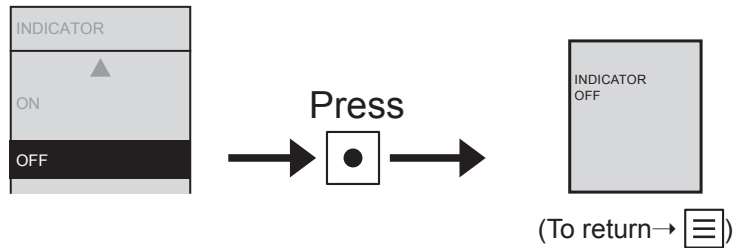

# Changing Settings

## Language Settings

1  Press.

2   Select  
[语言 / 語言 / LANGUAGE].



Press 

Select the language displayed on the back of remote control  
**Language Settings**

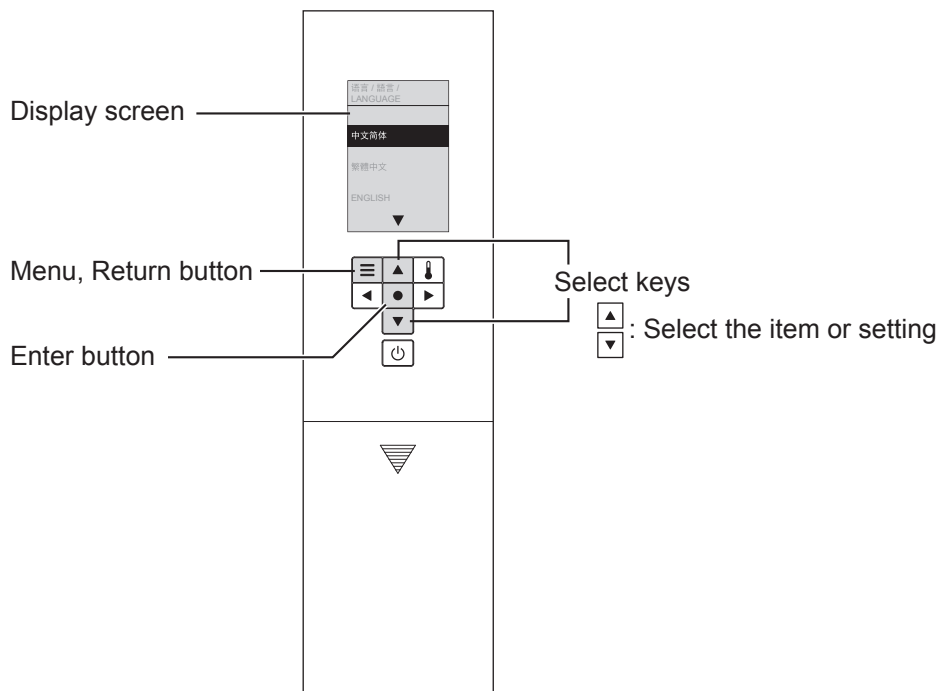

### Items set on this display

1. 中文简体  
"Simplified Chinese"
2. 繁體中文  
"Traditional Chinese"
3. ENGLISH  
"English"



# 3





Select

[ 中文简体 ], [ 繁體中文 ] or [ ENGLISH ].

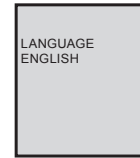

Press



(To return → )

# Changing Settings

## Other settings

1  Press.

2   Select  
[OTHER SETTING].



Press 

Set whether or not to make a beep sound  
**Beep sound**

Set whether or not to use the setting lock  
**Setting lock**

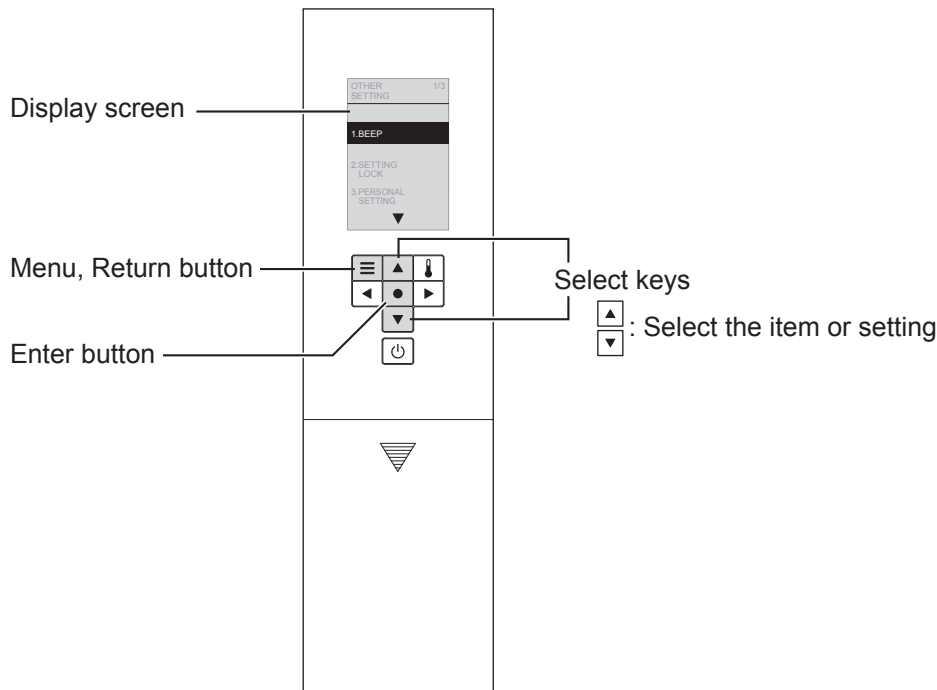



### Items set on this display

- 1. BEEP  
"Beep sound"
- 2. SETTING LOCK  
"Setting lock"
- 3. PERSONAL SETTING  
"Personal setting"

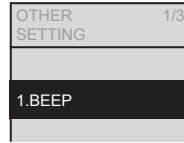
**3**  Select  
 [BEEP].



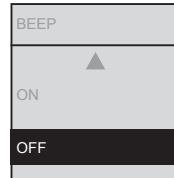

Press 

**4**  Select  
 [ON] or [OFF].



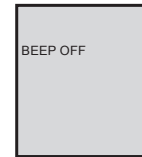

Press 



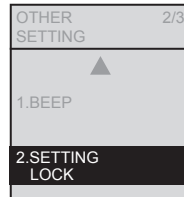

(To return → )

**3**  Select  
 [SETTING LOCK].



Press 

**4**  Select  
 [ON] or [OFF].

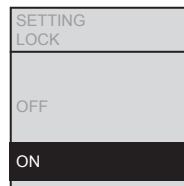

Press 

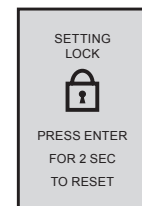

**5** Check the displayed screen.

Display screen during setting lock

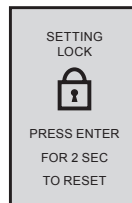

Cancellation method:

 Press "Enter"

for 2 seconds or longer.

\*If you want to relock after cancellation, reconfigure the setting.

# Changing Settings

## Other settings (Continued)

1  Press.

2   Select  
[OTHER SETTING].



Press 

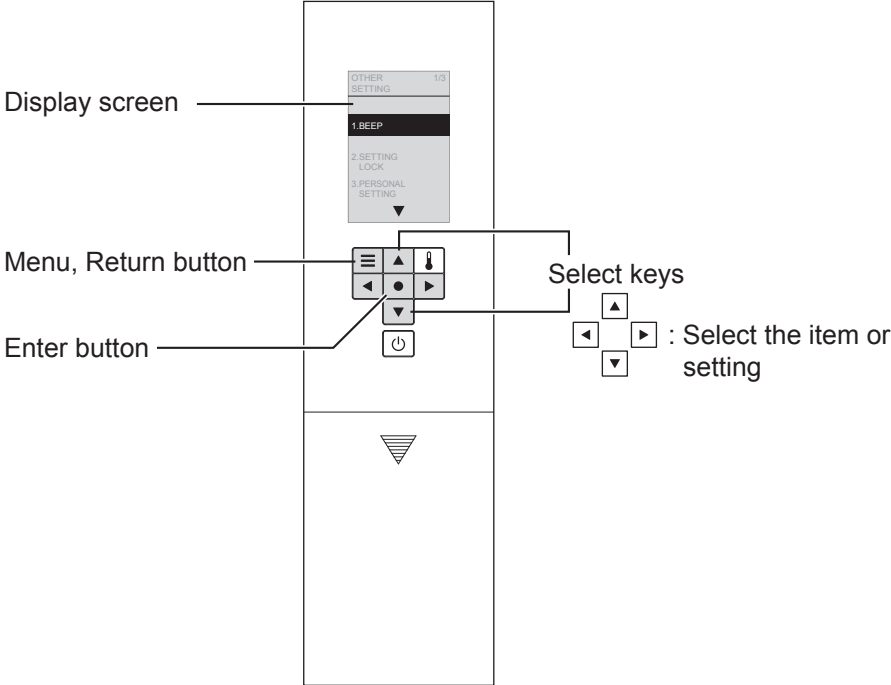

Set whether or not to use the personal setting  
**Personal setting Setting**

Set to remember your favorite pressure, wand position and water temperature settings  
**Personal setting Register1 Register2**



**Items set on this display**

- 1. BEEP  
"Beep sound"
- 2. SETTING LOCK  
"Setting lock"
- 3. PERSONAL SETTING  
"Personal setting"

**3**  Select  
 [PERSONAL SETTING].

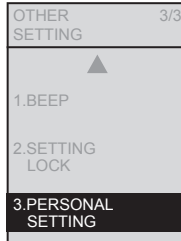

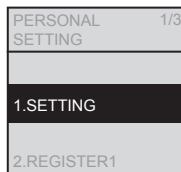

Press 

**4**  Select  
 [SETTING].





Press 

**5**  Select  
 [ON] or [OFF].



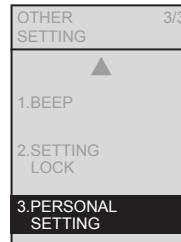

Press  →  (To return → )

**3**  Select  
 [PERSONAL SETTING].





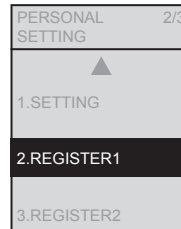

Press 





**4**  Select  
 [REGISTER1] or [REGISTER2].



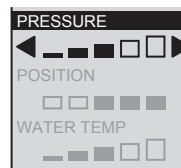



Press 

**5**  Select [PRESSURE] and  
   Set the water pressure.

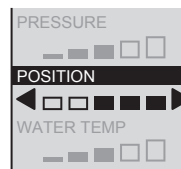

**6**  Select [POSITION] and  
   Set the wand position.



**7**  Select [WATER TEMP] and  
   Set the water temperature.

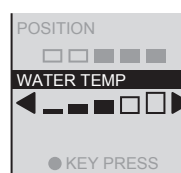

Press  →  (To return → )

# What to Do?

**If the water does not flow due to a water service interruption**

**If you cannot operate with the remote control**

**If the water does not flow due to a water service interruption**

**1** Use a bucket to flush water.

**2** If the water level is low after flushing, add more water.

- Prevents odors.

**Attention!**

- Before starting work, set "AUTO FLUSH" to "OFF" (only when "FLUSH" button is located on the top side of the remote control). (Page 44)
- When the water supply is restored, be sure to perform a full flush. (To prevent waste from remaining in the drain pipe.)

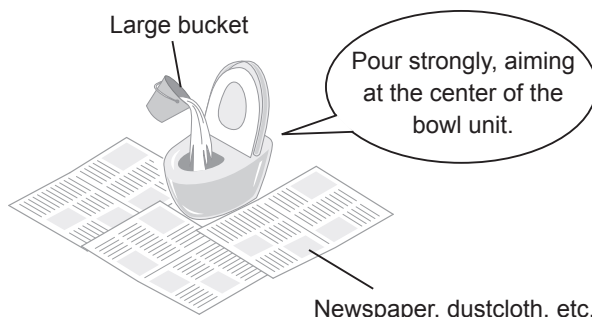

**If you cannot operate with the remote control**

■ If the low battery warning mark "🔋" on the display screen on the back of the remote control lights up, please replace the batteries.

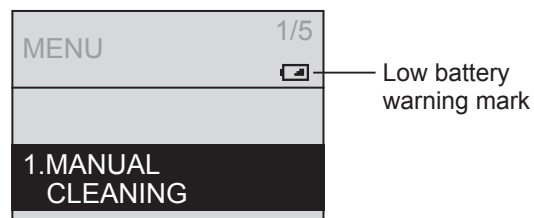

■ **Replacing the batteries**

**1** Unplug the power plug.

**2** Remove the remote control from the hanger.  
(Page 18)

**3** Open the battery cover and replace two AA batteries.

- (Page 18)
- The low battery warning mark goes off.

**4** Mount the remote control in the hanger.

**5** Insert the power plug.  
• The "Power" LED lights up.

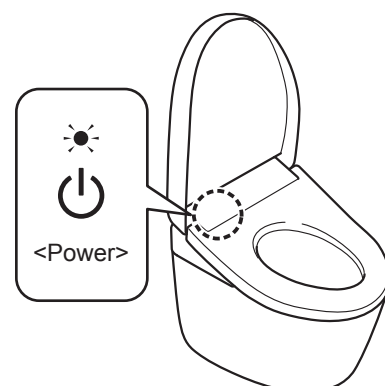

**Attention!**

- "ON" and "OFF" settings of the functions such as the energy saver function may be canceled when the batteries are replaced. Set them again.

# Freeze Damage Prevention

When the ambient temperature is likely to drop to 0°C or lower, take measures to prevent freezing.

## Attention!

- When the ambient temperature is likely to drop to 0°C or lower, do not use the energy saver feature. (May damage the product.)
- Warm the bathroom or take measures against freezing so that the ambient temperature does not drop below 0°C.
- Before starting work, set "AUTO FLUSH" (only when "FLUSH" button is located on the top side of the remote control) (Page 44) and "Auto open/close" (Except SW3046AT40, SW3046, SW3044AT40, SW3044) (Page 46) to "OFF".

## How to freeze damage prevention

### 1 Close the shutoff valve. (Page 41 Step 1)

- The water supply stops.

#### CAUTION

 Do not remove the water filter drain valve while the shutoff valve is open.

(Otherwise, water may leak out.)

### 2 Drain the water from the toilet tank.

- Manipulate the lever/button/etc. until the water stops.

### 3 Press

"Wand CLEAN" button.

- Open the wand cover.  
(Release the pressure from the water supply pipe.)

### 4 Unplug the power plug.

### 5 Drain the pipe.

- Remove the cover and water filter drain valve.
  - Loosen the water filter drain valve with a flat-head screwdriver and then pull it.

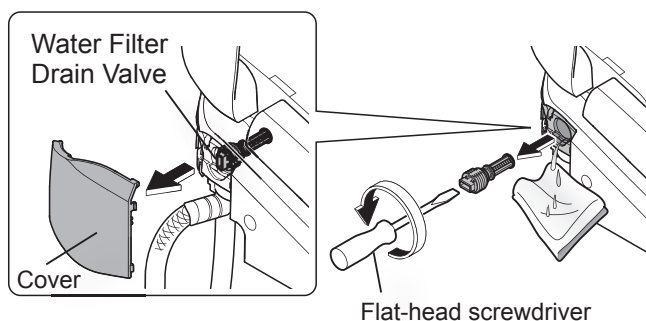

### 2 Drain the water from the water supply hose.

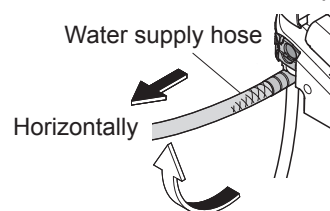

### 3 After draining the water, install the water filter drain valve and cover.

- Insert the water filter drain valve and use a flat-head screwdriver to tighten it securely.

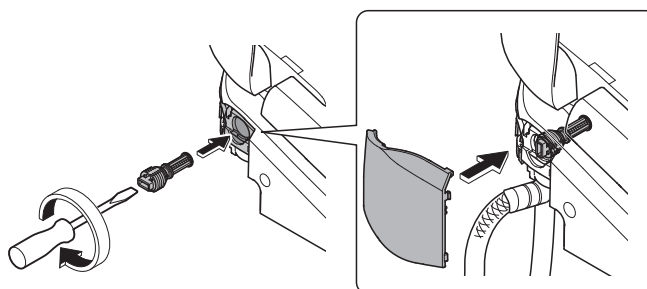

### 6 Insert the power plug.

- The "Power" LED lights up.

### 7 Set the toilet seat temperature to "High". (Page 28)

- To maintain the temperature, close the toilet seat and toilet lid after finishing work.

### ■ To use the product again

- The water needs to be resupplied. (Page 64)

# What to Do?

## Long Periods of Disuse

If the toilet is in a location you will not visit for a long time, drain the water.

(The water in the tank may cause malfunctions or become contaminated and cause skin irritation or other problems.)

### How to drain the water

**1** Drain the water from the toilet tank.  
(Page 63 Step **1**, **2**)

**2**  Press  
"Wand CLEAN" button.  
• Open the wand cover.  
(Release the pressure from the water supply pipe.)

**3** Unplug the power plug.

**4** Drain the pipe.  
(Page 63 Step **5**)

**5** Pull out the water drain lever.  
• Water comes out from around the wand  
(about 20 seconds)

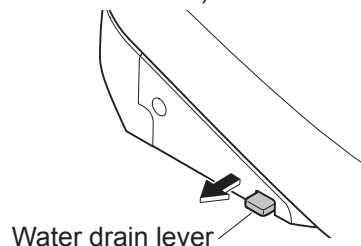

**6** Release your hand to return the water drain lever to its original position.

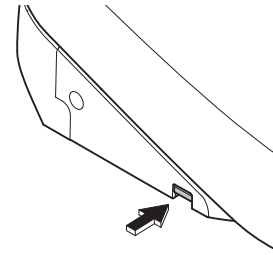

#### ■ If water may get frozen

- Add antifreeze solution in the water in the bowl to prevent freezing.  
(The antifreeze solution should not be flushed out. Collect it before using the toilet and dispose of it.)



#### ■ To use the product again

- The water needs to be resupplied. (See below)

### Resupplying the Water

**1** Open the shutoff valve. (Page 19)  
• Check that water is not leaking from a pipe or the main unit.

**2** If the power is not on,  
insert the power plug.  
• The "Power" LED lights up.

**3** Discharge water from the wand.  
(1) Pressing down the left side of the toilet seat,  
(2)  Press "Rear cleansing" button on the remote control to discharge water from the wand.  
• Catch the water in a paper cup or other receptacle.  
(3)  Press "Stopping" button.

#### ■ If the remaining water has frozen and no water comes out

- Heat the inside of the bathroom, and warm the water supply hose and shutoff valve using a cloth soaked in warm water.

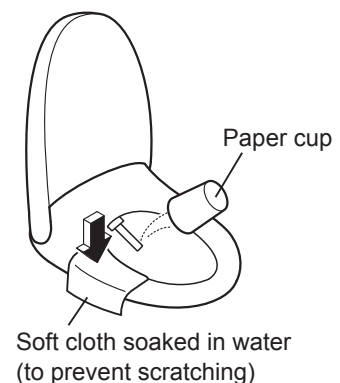



# Removal of Operation Guide

Follow the procedure below.

## How to remove the operation guide

- 1 Unplug the power plug.
- 2 Remove the remote control from the hanger.  
(Page 18)
- 3 Remove the hanger and operation guide.

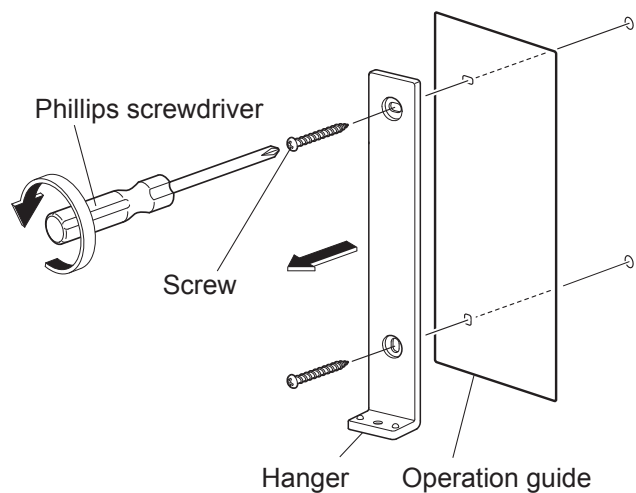

- 4 Screw the hanger on the wall.

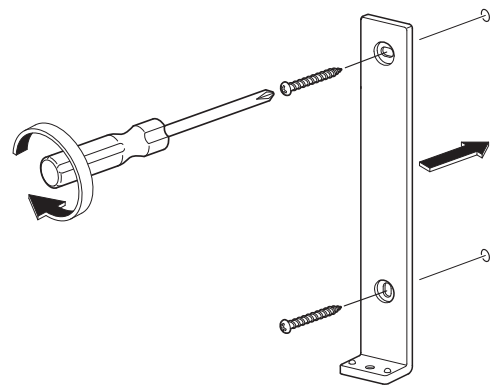

- 5 Mount the remote control in the hanger.

- 6 Insert the power plug.
  - The "Power" LED lights up.

■ To install back the operation guide, follow the procedure above.  
(Install the operation guide at step 4.)

# Troubleshooting

First, try the actions described on pages 66 - 72.

If the problem persists, consult the installer, seller or TOTO customer service (see contact information on the back cover).

**CAUTION**

! If a water leak occurs, close the shutoff valve.

## Please check first

**Is the Power LED lit?**

- Is the "Power ON/OFF" setting "OFF"?  
→ Switch it to "ON" with the remote control. (Page 19 Step 2-2)
- Is the "Power" LED on the main display flashing?  
→ The main unit is not mounted properly. Mount them correctly again. (Pages 38, 39)
- Is the power plug inserted?  
→ Check whether there is a power outage.

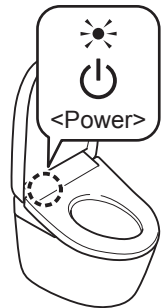

**Is the Energy saver LED lit?**



- While the LED is lit, energy saver (Page 30) is in operation, so the toilet seat temperature may be reduced or the heater may be turned off.

**Is the remote control working?**

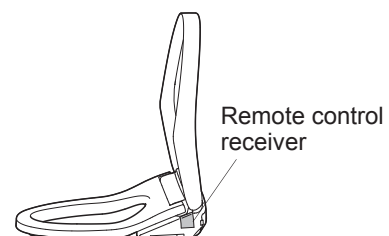
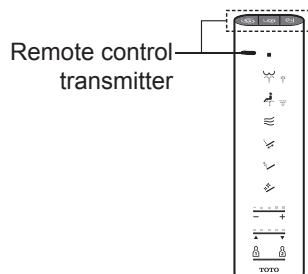
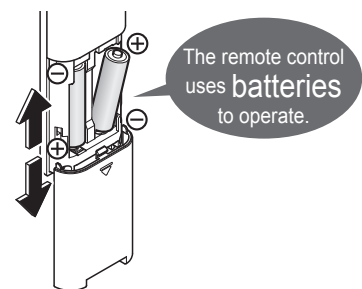
- Does the display screen on the back of the remote show " "?  
→ Replace the batteries. (Pages 18, 62)
- Is the remote control transmitter or the remote control receiver blocked?  
→ Remove obstructions, dirt, water droplets or any other blockages.



## Rear Cleansing, Front Cleansing and Wand

Trouble	Please check	Ref. Page
<b>The wand (or cleansing water) does not come out</b>	<ul style="list-style-type: none"> <li>● When the temperature is low, it takes time for the wand to come out after the remote control button is pressed because the water must be warmed up first.</li> </ul>	-
	<ul style="list-style-type: none"> <li>● Did you sit on the toilet continuously for 2 hours or longer? (If so, operation is stopped for safety purposes.) → Stand up from the seat and then use again.</li> </ul>	-
	<ul style="list-style-type: none"> <li>● If the water supply pressure drops significantly, for example if water is used elsewhere or if there is a water failure, the function may stop for safety. → Unplug the power plug and wait about 10 seconds before inserting it again. If the same symptom reappears. → There may be a malfunction. Consult with TOTO customer service (see contact information on the back cover).</li> </ul>	-
	<ul style="list-style-type: none"> <li>● The seat switch will not turn on unless you sit on the seat properly. → Sit back on the toilet seat.</li> </ul>	11
	<ul style="list-style-type: none"> <li>● Are you using a toilet seat cover, a toilet lid cover or a seat for infants? → Remove any covers. When using a seat for infants or a soft highchair, remove after each use.</li> </ul>	11
	<ul style="list-style-type: none"> <li>●  Are you pressing "Wand CLEAN" button on?  <ul style="list-style-type: none"> <li>•  When you press "Wand CLEAN" button, "ewater+" comes out from the vicinity of the wand to clean the wand.</li> </ul> </li> <li>→ To clean the wand with it extended, perform "Wand cleaning".</li> </ul>	37
<b>The wand extends but the cleansing water does not come out / The cleansing water pressure is weak</b>	<ul style="list-style-type: none"> <li>● Has a water failure occurred? → ■ Press "Stopping" button on the remote control and wait until water service is restored.</li> </ul>	-
	<ul style="list-style-type: none"> <li>● Is the shutoff valve closed?</li> </ul>	19
	<ul style="list-style-type: none"> <li>● Is the water filter drain valve clogged with foreign matter? → Clean the filter.</li> </ul>	41
	<ul style="list-style-type: none"> <li>● Is the water pressure set to a low level?</li> </ul>	21
<b>The cleansing water is cold</b>	<ul style="list-style-type: none"> <li>● Is the warm water temperature set to "OFF" or a low level?</li> </ul>	28
	<ul style="list-style-type: none"> <li>● When the temperature of the water supply or the bathroom is low, the water temperature may be low when first sprayed.</li> </ul>	-
<b>Stops in the middle of use</b>	<ul style="list-style-type: none"> <li>● "Rear cleansing", "rear soft cleansing", "front cleansing" and "wide front cleansing" stop automatically after about 5 minutes of continuous use.</li> </ul>	-
	<ul style="list-style-type: none"> <li>● Does the seat switch have difficulty detecting? → Sit back on the toilet seat. If you get up slightly from the seat, or sit forward on the seat, the seating switch may temporarily stop detecting your presence.</li> </ul>	11
<b>Water comes out unexpectedly from the wand</b>	<ul style="list-style-type: none"> <li>● When you sit on the toilet seat, water comes out for several seconds while water is warmed up.</li> </ul>	-
	<ul style="list-style-type: none"> <li>● Has the CLEAN indicator lit up in a cycle? • "Auto wand CLEAN" starts and the wand is cleaned.</li> </ul>	24



# Troubleshooting

## Warm air drying

Trouble	Please check	Ref. Page
The dryer temperature is low	<ul style="list-style-type: none"> <li>● Is the dryer temperature set to low level?</li> </ul>	28
Stops in the middle of use	<ul style="list-style-type: none"> <li>● The feature stops automatically after about 10 minutes of continuous use.</li> <li>● Does the seat switch have difficulty detecting?                             <ul style="list-style-type: none"> <li>→ Sit back on the toilet seat. If you get up slightly from the seat, or sit forward on the seat, the seating switch may temporarily stop detecting your presence.</li> </ul> </li> </ul>	- 11

## Flushing\*1

Trouble	Please check	Ref. Page
For not flushing	<ul style="list-style-type: none"> <li>● Is the shutoff valve fully open?</li> </ul>	19
	<ul style="list-style-type: none"> <li>● Has a water failure occurred?                             <ul style="list-style-type: none"> <li>→ Use a bucket to flush water.</li> </ul> </li> </ul>	62
The toilet does not flush even when the button is pressed	<ul style="list-style-type: none"> <li>● Are you pressing the button repeatedly? (After pressing the flush button, operation will not be accepted for about 10 to 20 seconds.)</li> </ul>	-
The bowl unit does not clean automatically or timing is delayed (Auto flushing)	<ul style="list-style-type: none"> <li>● Is "Auto flushing" set to "OFF"? → Set to "ON".</li> <li>● Even if "Auto flushing" is set to "ON", it is not available in the following instances                             <ul style="list-style-type: none"> <li>• About 60 seconds after the toilet is flushed.                                     <ul style="list-style-type: none"> <li>→ Wait about 60 seconds and flush the toilet with the remote control.</li> </ul> </li> <li>• When the time spent sitting on the toilet seat or standing in front of the bowl unit*2 is less than about 6 seconds.                                     <ul style="list-style-type: none"> <li>→ Flush with the remote control.</li> </ul> </li> <li>• When staying in front of the bowl unit after standing and using the toilet*2.                                     <ul style="list-style-type: none"> <li>→ The water flows after a maximum of about 20 seconds from when you leave the bathroom.</li> </ul> </li> </ul> </li> <li>● The seat switch will not turn on unless you sit on the seat properly.                             <ul style="list-style-type: none"> <li>→ Sit back on the toilet seat.</li> </ul> </li> </ul>	44 20 20 11
	<ul style="list-style-type: none"> <li>● The timing for the "Auto flushing" can be changed. (After about 10 seconds → after about 5 or 15 seconds)</li> </ul>	36
	<ul style="list-style-type: none"> <li>● Is "Auto flushing" set to "ON"? → You can turn it "OFF".</li> <li>● Does the seat switch or the body sensor have difficulty turning on or detecting?                             <ul style="list-style-type: none"> <li>→ Sit back on the toilet seat. If you lift your hip off the toilet seat during use or sit forward on it, the seat switch may not turn on, and thus auto flushing may occur during use.</li> </ul> </li> </ul>	36 11
The toilet flushes on its own	<ul style="list-style-type: none"> <li>● Is "Auto flushing" set to "ON"? → You can turn it "OFF".</li> <li>● Does the seat switch or the body sensor have difficulty turning on or detecting?                             <ul style="list-style-type: none"> <li>→ Sit back on the toilet seat. If you lift your hip off the toilet seat during use or sit forward on it, the seat switch may not turn on, and thus auto flushing may occur during use.</li> </ul> </li> </ul>	36 11

\*1 Available only when "FLUSH" button is located on the top side of the remote control.

\*2 Except SW3046AT40, SW3044AT40

## Toilet Seat and Toilet Lid (Auto open/close)

Trouble	Please check	Ref. Page
<p><b>The toilet lid does not open automatically</b></p>	<ul style="list-style-type: none"> <li>● Is "Auto open/close" set to "OFF"? →Set to "ON".</li> <li>● Even when set to "ON", "Auto open/close" is not performed for about 15 seconds after the toilet seat or toilet lid is closed.                             <ul style="list-style-type: none"> <li>• When the toilet lid is closed by hand (To make the product more user-friendly, a time interval is set from when the lid is closed to when it will open next.)</li> </ul> </li> </ul> <p>→Move away from the toilet and wait at least about 15 seconds before approaching the bowl unit again or open and close by hand.</p>	<p>46</p> <p>-</p>
	<ul style="list-style-type: none"> <li>● Is "Auto open delay" set to "30 seconds" or "90 seconds"?</li> </ul>	<p>48</p>
	<ul style="list-style-type: none"> <li>● After the power plug is inserted, the toilet lid does not open automatically for about 10 seconds. →Open and close by hand.</li> </ul>	<p>-</p>
	<ul style="list-style-type: none"> <li>● Is a toilet lid or seat cover installed? →Remove any covers.</li> </ul>	<p>11</p>
	<ul style="list-style-type: none"> <li>● Detection by the body sensor may be difficult when the toilet is used by someone small, such as a child.</li> </ul>	<p>-</p>
<p><b>The toilet lid does not close automatically</b></p>	<ul style="list-style-type: none"> <li>● Is "Auto open/close" set to "OFF"? →Set to "ON".</li> <li>● In the following cases, the toilet lid closes in about 5 minutes.                             <ul style="list-style-type: none"> <li>• When you did not sit on the toilet seat</li> <li>• When you sat on the toilet seat for less than 6 seconds</li> <li>• When you stood in front of the bowl unit for less than 6 seconds</li> </ul> </li> </ul>	<p>46</p> <p>-</p>
<p><b>The toilet lid opens on its own</b></p>	<ul style="list-style-type: none"> <li>● Is a urinal or wash basin also installed in the bathroom? →The body sensor may detect someone using the urinal, causing the toilet lid to open or close.</li> <li>● Because the body sensor can detect movement through the wall or door in front of the toilet, the "Auto open/close" function may cause the toilet lid to open automatically even when you are outside of the room. →You can switch "Auto open/close" to OFF.</li> </ul>	<p>11</p>
		<p>46</p>

# Troubleshooting

## Toilet Seat and Toilet Lid (Auto open/close)

Trouble	Please check	Ref. Page
The toilet lid closes on its own	● Is "Auto open/close" set to "ON"? → You can turn it "OFF".	46
	● Is "Auto close delay" set to "25 seconds"?	46
	● The seat switch will not turn on unless you sit on the seat properly. → Sit back on the toilet seat.	11
The toilet lid and toilet seat open at the same time	● Is "Seat/lid" set to "Seat·lid"?	48
Stops (or closes) while opening	● If the lid or seat hits an obstruction the first time it opens after the power plug is inserted, it may stop (or close) partway during the next operation. → Eliminate any obstructions and unplug the power plug. Insert the power plug again after about 5 seconds. Then press  "Opening and closing the toilet seat" button.	-
Cannot open or close with the remote control	● If it opens automatically. → Check "Is the remote control working?"	66
	● If automatic opening does not work either <ul style="list-style-type: none"> <li>• The toilet lid may not be mounted correctly.</li> </ul> → Mount them correctly.	40
	● Incorrect detection may occur when operating under fluorescent lights.	-

## Toilet Seat and Toilet Lid

Trouble	Please check	Ref. Page
The toilet seat is cold	● Is the toilet seat temperature set to "OFF" or a low level?	28
	● Is energy saver in operation? <ul style="list-style-type: none"> <li>• The energy saver feature is on when the "Energy saver" LED is on and the "Power" LED is off on the main display.</li> </ul> When you sit on the seat, the toilet seat heater is turned on temporarily and the seat is warmed in about 15 minutes. → You can turn it "OFF" if the energy saver feature is "ON".	30 32
	● Have you been seated for a long time? <ul style="list-style-type: none"> <li>• After about 20 minutes of sitting, the temperature starts going down, and after about 1 hour, the toilet seat heater is turned "OFF".</li> </ul> → Stand up from the seat and then use again.	-
	● The seat switch will not turn on unless you sit on the seat properly. → Sit back on the toilet seat.	11
	● Is a toilet lid or seat cover installed? → Remove any covers.	11

## Energy Saver

Trouble	Please check	Ref. Page
The Energy saver LED does not light up	<ul style="list-style-type: none"> <li>● Did you unplug the power plug or was there a power outage?                             <ul style="list-style-type: none"> <li>• The "Energy saver" LED on the main display may go off when the power is turned on even if the energy saver feature is "ON". (It will turn on within about 24 hours since the setting is retained.)</li> </ul> </li> </ul>	-
The timer energy saver feature is not working	<ul style="list-style-type: none"> <li>● Did you replace the remote control batteries?                             <ul style="list-style-type: none"> <li>• "Timer energy saver" may be canceled when the batteries are replaced. →Set the timer energy saver again at the time you want to start it.</li> </ul> </li> </ul>	32
The auto energy saver+ or auto energy saver feature is not working	<ul style="list-style-type: none"> <li>● Because the function takes several days learning the usage conditions before starting energy saver, the amount of energy saving may be low, depending on the frequency of use. →Check the energy saver setting.</li> </ul>	30

## Deodorizer

Trouble	Please check	Ref. Page
The deodorizer seems to be not working	<ul style="list-style-type: none"> <li>● Is "Deodorizer" set to "OFF"? →Set to "ON".</li> <li>● Even after sitting down, you do not hear operation sounds. →Sit back on the toilet seat.</li> <li>● If you hear an operation sound from the deodorizer, but odours are not removed. →Clean the deodorizing filter.</li> </ul>	52 - 36
A strange odor is emitted	<ul style="list-style-type: none"> <li>● Are you using an air freshener or deodorizer that you purchased separately?                             <ul style="list-style-type: none"> <li>• Doing so may reduce the effectiveness of the product's deodorizer or cause strange odors. →Remove the air freshener or deodorizer.</li> </ul> </li> </ul>	-
The auto power deodorizer feature is not working	<ul style="list-style-type: none"> <li>● Is "Auto power deodorizer" set to "OFF"? → Set to "ON".</li> <li>● It starts about 10 seconds after you stand up from the toilet seat.</li> </ul>	52 -

## Sanitary

Trouble	Please check	Ref. Page
The soft light, bowl light and CLEAN indicator do not light up	<ul style="list-style-type: none"> <li>● Is the "Soft light", "Bowl light" and "CLEAN indicator" setting "OFF"? →Set to "ON".</li> <li>● If the "CLEAN indicator" LED is not lit, it is time to replace the component that generates "ewater+". (Replacement will be charged) Consult the installer, seller, or TOTO customer service (see contact information on the back cover).</li> </ul>	54 -
Pre-mist and after-mist do not work	<ul style="list-style-type: none"> <li>● Is "Auto bowl CLEAN" set to "OFF"? →Set to "ON".</li> <li>● The following functions do not work when the toilet seat is open.                             <ul style="list-style-type: none"> <li>• Is "Seat/lid" of "Auto open/close" set to [Seat•lid]? →You can change it to "Lid".</li> </ul> </li> <li>● The pre-mist does not work for about 90 seconds after the after-mist has finished.</li> </ul>	50 48 -
The pre-mist sprays out spontaneously	<ul style="list-style-type: none"> <li>● Because the body sensor can detect movement through the wall or door in front of the toilet, the "Auto bowl CLEAN" function may cause the toilet to pre-mist even when you are outside of the bathroom. →You can switch "Auto bowl CLEAN" to OFF.</li> <li>● If the cleansing functions (e.g., Rear cleansing and Front cleansing) are not used for about 8 hours, "Auto bowl CLEAN" starts and mist is sprayed inside the bowl unit.</li> </ul>	50 25

# Troubleshooting

Others		
Trouble	Please check	Ref. Page
Water is leaking from the plumbing connections	<ul style="list-style-type: none"> <li>● If the nut of the connecting pipe is loosened, retighten it by hand. (Do not use any tool.) → If the water leak does not stop, close the shutoff valve and consult with TOTO customer service (see contact information on the back cover).</li> </ul>	-
The display on the remote control goes out	<ul style="list-style-type: none"> <li>● The display goes out when no button on the remote control is pressed for about 60 seconds or more.</li> </ul>	18
The main unit is unstable	<ul style="list-style-type: none"> <li>● There is clearance between the toilet seat cushion and the bowl unit for activating the seat switch. When you sit on the toilet seat, the toilet seat subsides slightly to activate the seat switch.</li> <li>● Are the bolts that anchor the main unit loose? → Remove the main unit and then firmly tighten the base plate bolts.</li> </ul>	11 38,39
The main unit makes a sound	When entering the bathroom	
	<ul style="list-style-type: none"> <li>● If "Auto bowl CLEAN" is "ON", you may hear that pre-mist is spraying mist in the bowl unit to make it more difficult for dirt to adhere. → You can turn it "OFF".</li> </ul>	50
	When using the cleansing (rear cleansing, rear soft cleansing, front cleansing) function	
	<ul style="list-style-type: none"> <li>● You can hear the sound of the pump operating while cleansing water is being supplied.</li> </ul>	-
	When moving away from the bowl unit after use	
	<ul style="list-style-type: none"> <li>● When "Auto power deodorizer" is "ON", operation sounds are made while the deodorizing power increases for 60 seconds after you stand up from the toilet seat. → You can turn it "OFF".</li> <li>● If "Auto wand CLEAN" is "ON" and you use the cleansing functions (e.g., Rear cleansing and Front cleansing), you may hear that the wand is extended and cleaned with "ewater+". → You can turn it "OFF".</li> <li>● If "Auto bowl CLEAN" is "ON" and you sit on the toilet seat and use the toilet, you may hear that mist of "ewater+" is sprayed inside the bowl unit. → You can turn it "OFF".</li> <li>● You may hear that the wand is extended and the remaining water in the product is drained after "Auto wand CLEAN" and other functions are performed.</li> <li>● You may hear the fan ventilating the unit. (About 30 minutes)</li> </ul>	52 50 50 -
When not using the product (e.g., at night)		
<ul style="list-style-type: none"> <li>● You may hear the following sounds if "Auto wand CLEAN" or "Auto bowl CLEAN" is "ON" and if you do not use the cleansing functions (e.g., Rear cleansing and Front cleansing) for about 8 hours. "Auto wand CLEAN": Sound of cleaning the wand with "ewater+" : Sound of extending the wand and draining remaining water from the product after operation of functions "Auto bowl CLEAN": Sound of spraying mist of "ewater+" inside the bowl unit → You can turn it "OFF".</li> </ul>	50	



# Specifications

Item		SW3056AT40 SW3056	SW3046AT40 SW3046	SW3054AT40 SW3054	SW3044AT40 SW3044	
Rated power supply		AC 120 V 60 Hz				
Rated power consumption		1288 W	1287 W	1288 W	1287 W	
Maximum power consumption		1444 W	1443 W	1444 W	1443 W	
Type of water heater		Instantaneous type				
Power cord length		3.94 ft (1.2 m)				
Water protection level		IPX4				
Cleansing	Spray volume	Rear cleansing	Approx. 0.08 - 0.11 gal/min. (Approx. 0.32 - 0.43 L/min.) <at 29 PSI (0.20 MPa) water pressure>			
		Rear soft cleansing	Approx. 0.08 - 0.11 gal/min. (Approx. 0.32 - 0.43 L/min.) <at 29 PSI (0.20 MPa) water pressure>			
		Front cleansing	Approx. 0.08 - 0.11 gal/min. (Approx. 0.29 - 0.43 L/min.) <at 29 PSI (0.20 MPa) water pressure>			
		Wide front cleansing	Approx. 0.09 - 0.11 gal/min. (Approx. 0.35 - 0.43 L/min.) <at 29 PSI (0.20 MPa) water pressure>			
	Water temperature		Adjustable temperature range: OFF, about 86 - 104 °F (about 30 - 40 °C)			
	Heater capacity		1116 W			
	Safety device		Temperature fuse			
	Backflow prevention device		Vacuum breaker, Check valve			
Heated seat	Surface temperature		Adjustable temperature range: OFF, about 82 - 97 °F (about 28 - 36 °C) (Auto energy saver: about 79 °F (about 26 °C), Auto energy saver+: OFF)			
	Heater capacity		50 W			
	Safety device		Temperature fuse			
Deodorizer	Method		O <sub>2</sub> deodorization			
	Airflow volume		Normal mode: about 3.17 ft <sup>3</sup> /min (about 0.09 m <sup>3</sup> /min), Power mode: about 5.65 ft <sup>3</sup> /min (about 0.16 m <sup>3</sup> /min)			
	Power consumption		Normal mode: about 1.7 W, Power mode: about 5.3 W			
Warm air dryer	Warm air temperature <sup>*1</sup>		Adjustable temperature range : about 95 - 140 °F (about 35 - 60 °C)			
	Airflow volume		10.24 ft <sup>3</sup> /min (0.29 m <sup>3</sup> /min)			
	Heater capacity		347 W			
	Safety device		Temperature fuse			
Water supply pressure		Minimum required water pressure: 7.25 PSI (0.05 MPa) <dynamic>, Maximum water pressure: 108.75 PSI (0.75 MPa) <static>				
Water supply temperature		32 - 95 °F (0 - 35 °C)				
Working ambient temperature		32 - 104 °F (0 - 40 °C)				
Dimensions		W 1.25 ft. x D 1.74 ft. x H 0.41 ft. (W 383 mm x D 532 mm x H 125 mm)		W 1.25 ft. x D 1.73 ft. x H 0.42 ft. (W 383 mm x D 527 mm x H 127 mm)		
Weight		About 10 lb (About 5 kg)				

\*1 Temperature around the warm air outlet measured by TOTO.

● When disposing of this product, please follow your local or state guidelines for proper disposal.

# Limited Warranty

## One Year Limited Warranty

1. TOTO warrants its product to be free from defects in materials and workmanship during normal use when properly installed and serviced, for a period of one (1) year from date of purchase. This limited warranty is extended only to the ORIGINAL PURCHASER of the Product and is not transferable to any third party, including but not limited to any subsequent purchaser or owner of the Product. This warranty applies only to TOTO Product is purchased and installed in USA and Canada.
2. TOTO's obligations under this warranty are limited to repair, replacement or other appropriate adjustment, at TOTO's option, of the Product or parts found to be defective in normal use, provided that such Product was properly installed, used and serviced in accordance with instructions.  
TOTO reserves the right to make such inspections as may be necessary in order to determine the cause of the defect. TOTO will not charge for labor or parts in connection with warranty repairs or replacements. TOTO is not responsible for the cost of removal, return and/or reinstallation of the Product.
3. This warranty does not apply to the following items:
  - a) Damage or loss sustained in a natural calamity such as fire, earthquake, flood, thunder, electrical storm, etc.
  - b) Damage or loss resulting from any accident, unreasonable use, misuse, abuse, negligence, improper care, or maintenance of the Product.
  - c) Damage or loss resulting from sediments or foreign matter contained in a water system.
  - d) Damage or loss resulting from the quality of water in the region where the product is used.
  - e) Damage or loss resulting from improper installation or from installation of the Product in a harsh and/or hazardous environment, or improper removal, repair or modification of the Product. This includes locations where the water pressure is above local codes or standards. (NOTE : Product model codes allow a maximum of 80 PSI. Check local codes or standards for requirements).
  - f) Damage or loss resulting from electrical surges or lightning strikes or other acts which are not the fault of TOTO or which the Product is not specified to tolerate, including failure to use the factory equipped cord and plug or use of a loose or faulty electrical outlet or use of a current or socket other than a 120V, 60Hz electrical current from a GFI (ground, fused) socket.
  - g) Damage or loss resulting from normal and customary wear and tear, such as gloss reduction, scratching or fading over time due to use, cleaning practices or water or atmospheric conditions, including but not limited to, the use of bleach, alkali, acid cleaners, dry (powder) cleaners or any other abrasive cleaners or the use of metal or nylon scrubbers.
4. If the Danger Label which has been placed over the seams on the back of the Product's top unit is broken or otherwise not intact, this limited warranty is void.
5. In order for this limited warranty to be valid, proof of purchase is required. TOTO encourages warranty registration upon purchase to create a record of Product ownership at <http://www.totousa.com>. Product registration is completely voluntary and failure to register will not diminish your limited warranty rights.
6. If the Product is used commercially or is installed outside of USA or Canada. TOTO warrants the Product to be free from defects in materials and workmanship during normal use for one (1) year from the date of installation of the Product, and all other terms of this warranty shall be applicable except the duration of the warranty.
7. This warranty gives you specific legal rights. You may have other rights which vary from state to state, province to province or country to country.
8. To obtain warranty repair service under this warranty, you must take the Product or deliver it prepaid to a TOTO service facility together with proof of purchase (original sales receipt) and a letter stating the problem, or contact a TOTO distributor or products service contractor, or write directly to TOTO U.S.A., INC., 1155 Southern Road, Morrow, GA 30260 (888) 295 – 8134 or (678) 466-1300, if outside the U.S.A. If, because of the size of the Product or nature of the defect, the Product cannot be returned to TOTO, receipt by TOTO of written notice of the defect together with proof of purchase (original sales receipt) shall constitute delivery. In such case, TOTO may choose to repair the Product at the purchase's location or pay to transport the Product to a service facility.

WARNING! TOTO shall not be responsible or liable for any failure of, or damage to, this Product caused by either chloramines in the treatment of public water supply or cleaners containing chlorine (calcium hypochlorite).

NOTE: The use of a high concentrate chlorine or chlorine related product's can seriously damage the fittings. This damage can cause leakage and serious property damage.

THIS WRITTEN WARRANTY IS THE ONLY WARRANTY MADE BY TOTO. REPAIR, REPLACEMENT OR OTHER APPROPRIATE ADJUSTMENT AS PROVIDED UNDER THIS WARRANTY SHALL BE THE EXCLUSIVE REMEDY AVAILABLE TO THE ORIGINAL PURCHASER. TOTO SHALL NOT BE RESPONSIBLE FOR LOSS OF THE PRODUCT OR FOR OTHER INCIDENTAL, SPECIAL OR CONSEQUENTIAL DAMAGES OR EXPENSES INCURRED BY THE ORIGINAL PURCHASER, OR FOR LABOR OR OTHER COSTS DUE TO INSTALLATION OR REMOVAL, OR COSTS OF REPAIRS BY OTHERS, OR FOR ANY OTHER EXPENSE NOT SPECIFICALLY STATED ABOVE. IN NO EVENT WILL TOTO'S RESPONSIBILITY EXCEED THE PURCHASE PRICE OF THE PRODUCT. EXCEPT TO THE EXTENT PROHIBITED BY APPLICABLE LAW, ANY IMPLIED WARRANTIES, INCLUDING THAT OF MERCHANTABILITY OR FITNESS FOR USE OR FOR A PARTICULAR PURPOSE, ARE EXPRESSLY DISCLAIMED. SOME STATES DO NOT ALLOW LIMITATIONS ON HOW LONG AN IMPLIED WARRANTY LASTS, OR THE EXCLUSION OR LIMITATION OF INCIDENTAL OR CONSEQUENTIAL DAMAGES, SO THE ABOVE LIMITATION AND EXCLUSION MAY NOT APPLY TO YOU.

# MEMO

# TOTO

**TOTO U.S.A., Inc.**

1155 Southern Road Morrow, GA 30260

Phone : (770) 282-8686

**Warranty Registration and Inquiry**

For product warranty registration, TOTO U.S.A. Inc. recommends On-Line Warranty Registration. Please visit our web site <http://www.totousa.com>. If you have questions regarding warranty policy or coverage, please contact TOTO U.S.A. Inc.,

Customer Service Department, 1155 Southern Road, Morrow, GA 30260 (888) 295 - 8134 or (678) 466 - 1300 when calling from outside of U.S.A.

- You are advised to record the following information to allow quick service.

Date of purchase :	Name of shop :
Date : year month day	Tel : (     )

2019.12.16  
D07488R